

netsys

Networking your world

2 Megapixels Outdoor Bullet IP Camera

NC-22BC USER'S MANUAL



[Http://www.netsys.com.tw](http://www.netsys.com.tw)

Copyright



Copyright © 2012 by National Enhance Technology Corp. All rights reserved.

THE TRADEMARKS MENTIONED IN THE MANUAL ARE LEGALLY REGISTERED TO THEIR RESPECTIVE COMPANIES.

Safety Warnings

TO REDUCE THE RISK OF FIRE OR ELECTRIC SHOCK, DO NOT EXPOSE THIS PRODUCT TO RAIN OR MISTURE.
DO NOT INSERT ANY METALLIC OBJECT THROUGH VENTILATION GRILLS.

Caution:

	CAUTION RISK OF ELECTRIC SHOCK DO NOT OPEN	
CAUTION : TO REDUCE THE RISK OF ELECTRIC SHOCK. DO NOT REMOVE COVER (OR BACK). NO USER-SERVICEABLE PARTS INSIDE. REFER SERVICING TO QUALIFIED SERVICE PERSONNEL.		



NC-22BC is compliance **outdoor** applications. This product have IP-66 waterproof protection.



Table of Contents

Copyright.....	1
Safety Warnings.....	1
Foreword	4
Chapter 1. Package Contents	5
Chapter 2. Product Specifications	6
Chapter 3. Product Installation	10
3.1 Monitor Settings.....	10
3.2 Hardware Installation.....	11
3.3 IP Assignment	16
3.4 Install ActiveX Control.....	21
Chapter 4. Live Video	31
Chapter 5. Camera Configuration	35
5.1. System	36
5.2. Network.....	42
5.3. A / V Setting.....	67
5.4. Event List.....	80
Chapter 6. Network Configuration	93



Chapter 7. I/O Configuration	95
Chapter 8. Factory Default	99
Chapter 9. Universal Password	100
Appendix A. Micro SD Card Compatibility (Optional)	104
Appendix B: Compliance Information	105
Warranty	108
Chinese SJ/T 11364-2014	109

Foreword

NC-22BC is a 1 / 2.7" 2 Mega-Pixel CMOS sensor IP camera with a built-in web server. The user can view real-time video via IE browser. It supports H.264 and M-JPEG video compression, providing smooth and high video quality. The video can be stored in Micro SD card and playback remotely. With a user friendly interface, it is an easy-to-use IP camera for security applications.



Outward

Chapter 1. Package Contents

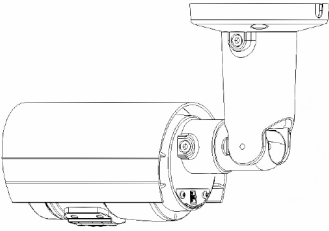
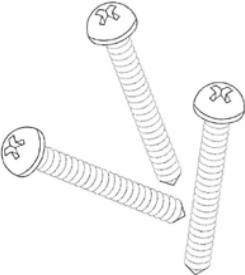
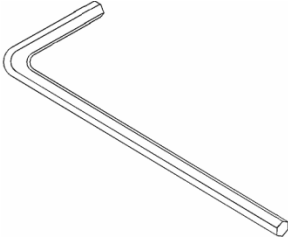
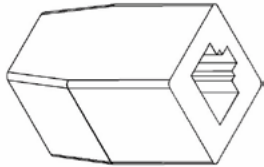
IP Camera	Screws	Hex Wrench	RJ45 Female to Female connector
			

Notes:

1. Please inform your dealer immediately for any missing or damaged parts. If possible, retain the carton including the original packing materials. Use them to repack the unit in case there is a need to return for repair.
2. If the product has any issue, please contact your local vendor.
3. The power supply included in the package is commercial-grade. Do not use in industrial-grade applications.
4. Please look for the QR code on the bottom of the product, the user can launch the QR code scanning program to scan and download the user's manual electronic format file.
5. This product can be used with PoE products, NV-202P is recommended.

Chapter 2. Product Specifications

Main Features

- Supports Full HD 1080P Real Time
- External Vari-focal Lens Adjustment
- 3D+2D Digital Noise Reduction
- Digital Wide Dynamic Range
- Power over Ethernet Available
- Day & Night Switch Time Control Manually
- IR Distance up to 25M
- Mechanism IR Cut Filter Available
- H.264/ M-JPEG Compression
- Supports Micro SD Card Backup (**Optional**)
- 2-way Audio
- Video Output
- IP-66
- Cable Management
- Supports for iOS/ Android / OS X / Windows
- SDK for Software Integration
- Free Bundle 36 Ch Recording Software

Hardware	
CPU	Multimedia SoC
RAM	256MB
Flash ROM	16MB
Image sensor	1 / 2.7" 2 Megapixel CMOS Sensor
Sensitivity	Color : 0.05 Lux (AGC ON) B / W : 0.01 Lux (AGC ON)
Lens Type	Vari-focal Lens 3-10.5 mm @ F1.4
View Angle	34.89°~106.72°(H), 19.38°~61.26°(V)
ICR	Mechanism IR cut Filter
I/O	1 DI/ 1 DO
Power over Ethernet	Yes
Video Output	Yes
Audio	G.711(64K) and G.726(32K,24K) audio compression Input : 3.5mm phone jack Output : 3.5mm phone jack Support 2-way.
Power Consumption	DC 12V Max : 2.76W(IR Off); 4.80W(IR On) PoE Max : 3.84W(IR Off); 6.72W(IR On)
Operating Temperature	-10°C ~ 50°C



NC-22BC 2 Megapixels IR IP Camera User's Manual Ver.A2

Dimensions	83mm (∅) x 180mm (H)
Weight	1350g
IR LEDs	
LEDs	35 units, 850nm
IR distance	25M
Network	
Ethernet	10/ 100 Base-T
Network Protocol	IPv6, IPv4, HTTP, HTTPS, SNMP, QoS/DSCP, Access list, IEEE 802.1X, RTSP, TCP/ IP, UDP, SMTP, FTP, PPPoE, DHCP, DDNS, NTP, UPnP, 3GPP, SAMBA, Bonjour
System	
Video Resolution	1920x1080@30fps, 1280x720@30fps, 640x480@30fps, 320x240@30fps, 176x144@30fps
Video Adjust	Brightness, Contrast, Hue, Saturation, Sharpness, AGC, Shutter Time, Sense-Up, D-WDR, Anti Fog, Lens Distortion Correction, Flip, Mirror, Day&Night Adjustable, Red Gain and Blue Gain, Denoise
Triple Streaming	Yes
Image Snapshot	Yes
Full Screen Monitoring	Yes
Privacy Mask	Yes, 3 different areas
Compression Format	H.264/ M-JPEG



Video Bitrates Adjust	CBR, CVBR
Motion Detection	Yes, 3 different areas
Triggered Action	Mail, FTP, Save to SD card, DO, SAMBA
Security	Password protection, IP address filtering, HTTPS encrypted data transmission, 802.1X port-based authentication for network protection, QoS/DSCP
Firmware Upgrade	HTTP mode, can be upgraded remotely
Simultaneous Connection	Up to 10
Micro SD card management (Optional)	
Recording Trigger	Motion Detection, IP check, Network break down (wire only),Schedule, DI
Video Format	AVI, JPEG
Video Playback	Yes
Delete Files	Yes
Web browsing requirement	
OS	Windows 7, 2000, XP, 2003, Microsoft IE 6.0 or above Browser: Chrome, Safari, Firefox
Mobile support	iOS 4.3 or above, Android 1.6 or above
Hardware Suggested	Intel Dual Core 2.53G RAM: 1G Graphic card: 128MB

Note: **SPECIFICATIONS ARE SUBJECT TO CHANGE WITHOUT NOTIFICATION.

Chapter 3. Product Installation

3.1 Monitor Settings

Step1 Right-Click on the desktop. Select **Properties**



Step2 Change color quality to highest (32bit).

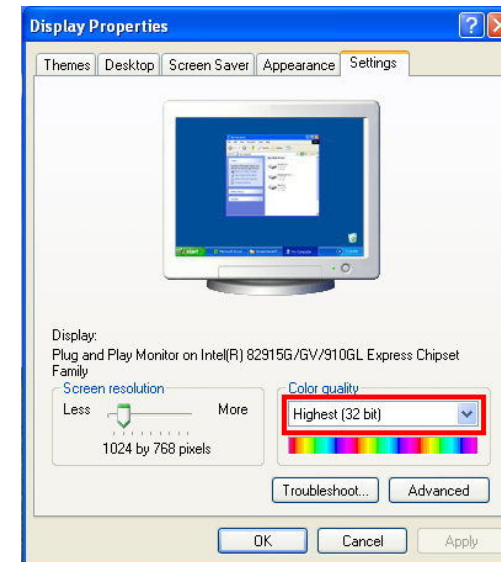

3.2 Hardware Installation

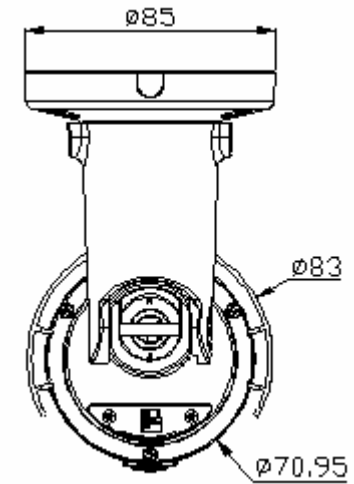
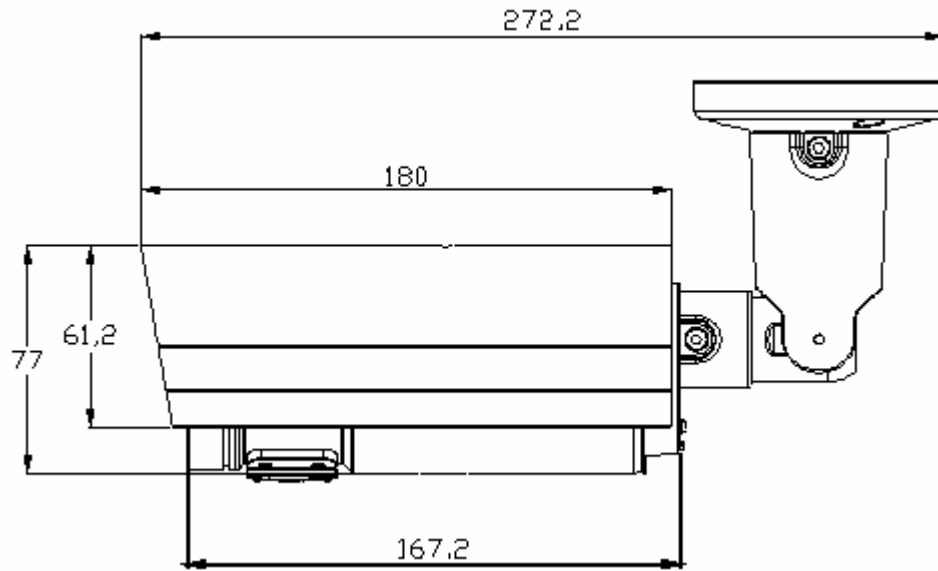

1. Connectors Instruction

The Cable and connectors are as below. Connect power adaptor first, then connect the IP Camera to PC or network, and set up the network configurations according to the network environment.

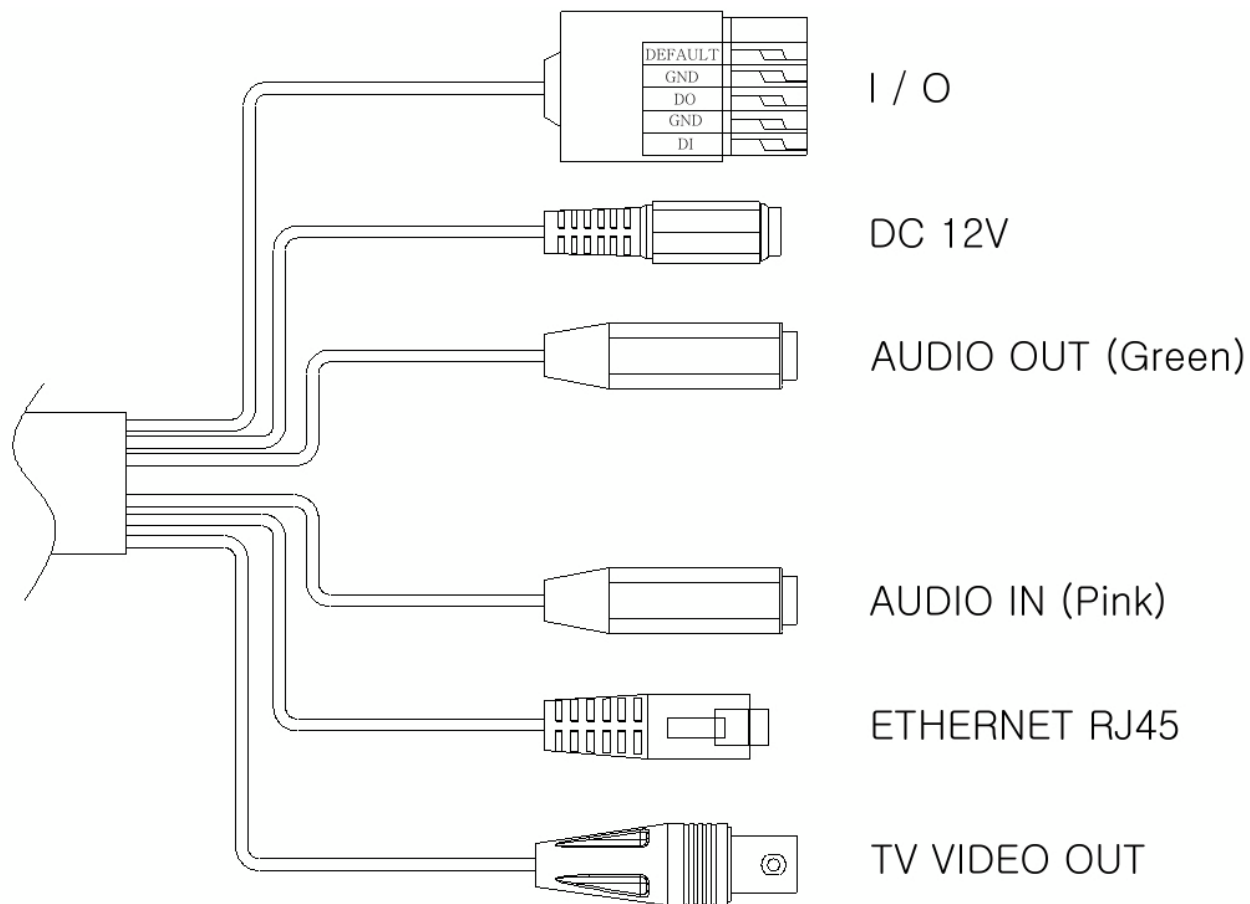

2. Adjust ZOOM and FOCUS

Adjust the **ZOOM** first and then **FOCUS** as following picture to complete the adjustment.

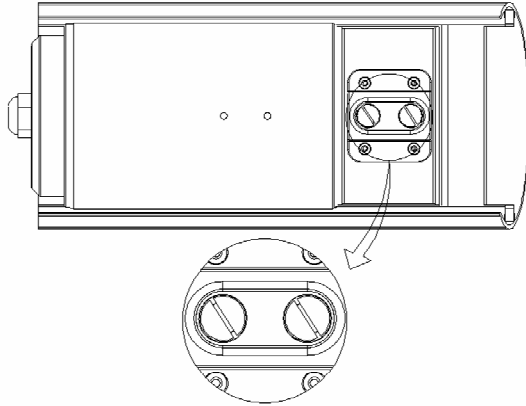

3. 3-Axis Bracket

Use the 3-Axis bracket to adjust the camera to appropriate angle, then turn and tighten the screw to fix it.

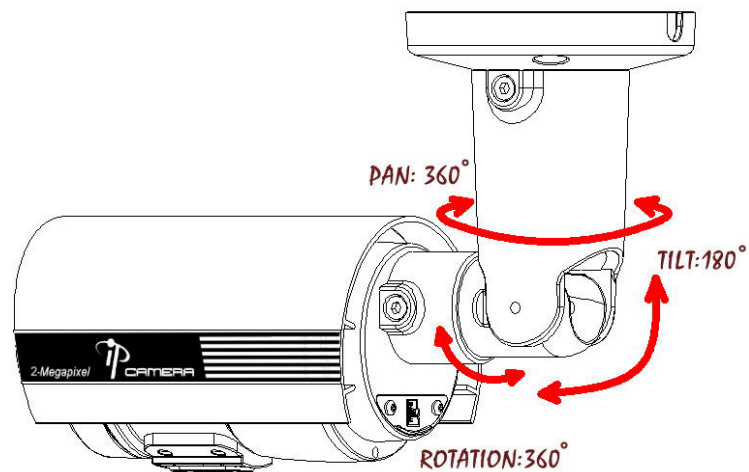

4. PoE (Power Over Ethernet)(Optional) 802.3af, 15.4W / 802.3at 30W Max.

*NV-202P is recommended

Power over Ethernet (PoE) is a technology that integrates power into a standard LAN infrastructure. It enables power to be provided to a network device, such as an IP phone or a network camera, using the same cable as that used for network connection. It eliminates the need for power outlets at the camera locations and enables easier application of uninterruptible power supplies (UPS) to ensure 24 hours a day, 7 days a week operation. NV-202P supports IEEE802.3af / IEEE 802.3at standard. (Figure 3.1)

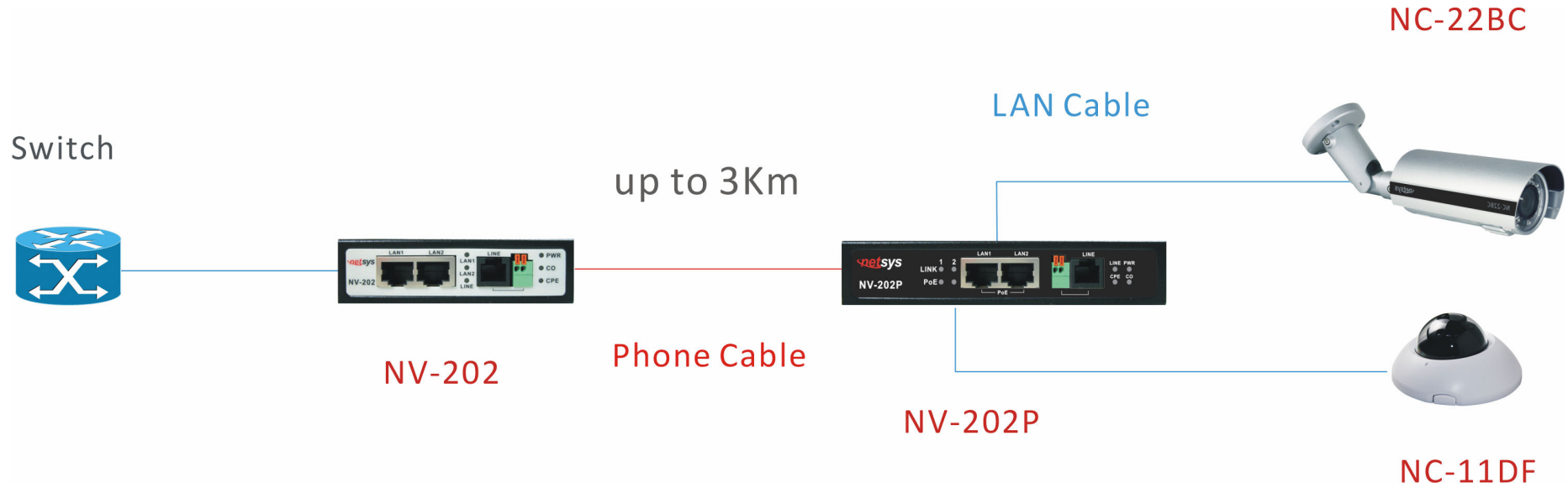

Figure 3.1 NV-202P KIT and IP-Camera applications

3.3 IP Assignment

1. Use the software **IP Installer** to assign the IP address of the IP Camera. The software is in the software CD attached to the product's package.

2. **IP installer** supports two languages:
 - a. IPInstallerCht.exe : Chinese version
 - b. IPInstallerEng.exe : English version

3. There are 3 kinds of IP configuration.
 - a. Fixed IP (Public IP or Virtual IP)
 - b. DHCP (Dynamic IP)
 - c. Dial-up (PPPoE)

4. Execute **IP Installer**

5. For Windows XP SP2 users, it may popup the following message box. Click **Unblock**.



6. **IP Installer** configuration:

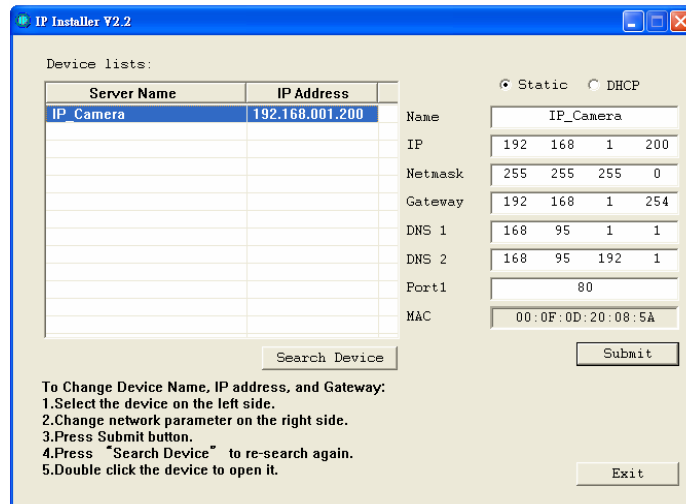

7. **IP Installer** will search for all the IP Cameras connected on the LAN. The user can click **Search Device** to search again.
8. Click one of the IP Cameras listed on the left side. The network configuration of this IP camera will be shown on the right side. You can change the **name** of the IP Camera to your preference (e.g.: Office, warehouse). Change the parameters and click **Submit**, then click **OK**, it will apply the changes and reboot the device.

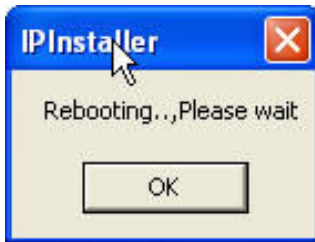

9. Please make sure the subnet of the PC IP address and the IP Camera IP address are the same.

The same Subnet:

IP Camera IP address: 192.168.1.200

PC IP address: 192.168.1.100

Different Subnets:

IP Camera IP address: 192.168.2.200

PC IP address: 192.168.1.100

To Change the PC IP address:

Control Panel→Network Connections→Local Area Connection Properties→Internet Protocol (TCP/IP) →Properties

Make sure your IP Camera and PC are int the same Subnet. If not, change the IP Camera subnet or the PC IP subnet accordingly.

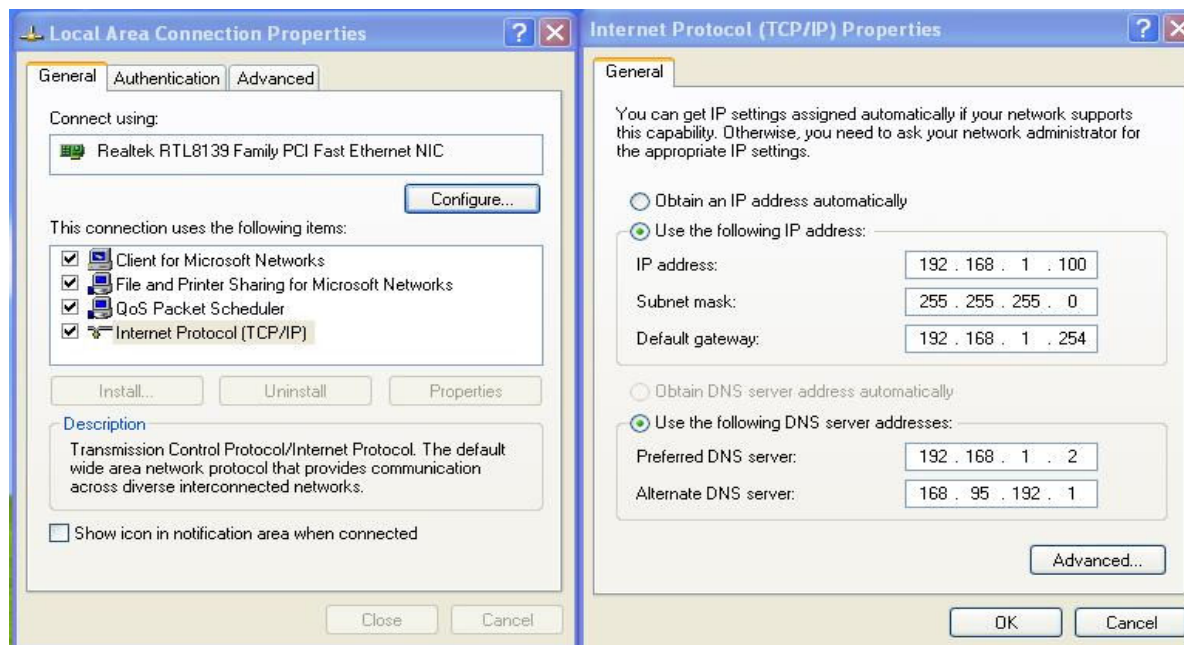

10. A quick way to access remote monitoring is to left-click the mouse twice, on a selected IP Camera, listed on **Device list of IP Installer**. An IE browser will be opened.

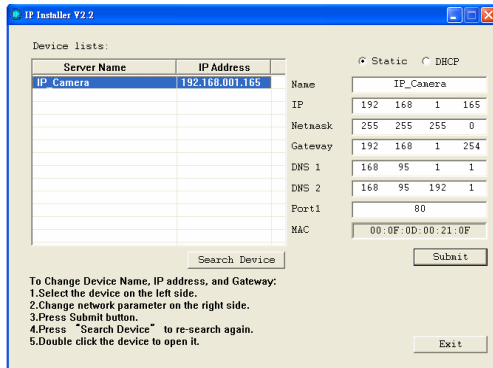

11. Then, key-in the default **user name: admin** and **password: admin**.



3.4 Install ActiveX Control

1. For users of IE 6.0 or above:

When viewing the camera video for the first time via IE, the browser will ask you to install the **ActiveX** component.

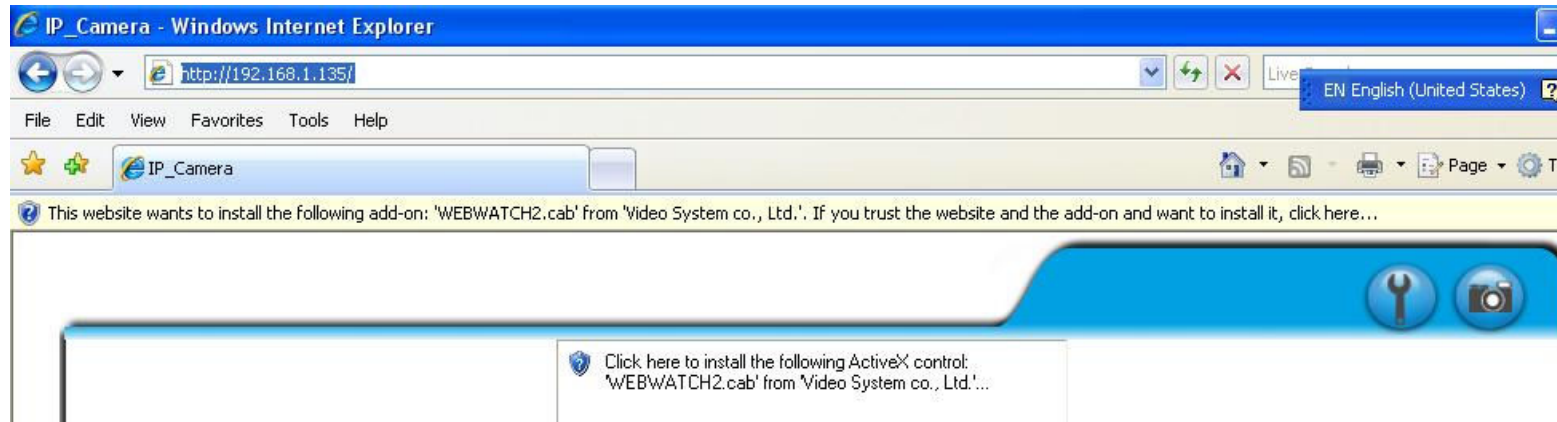

1. If the installation failed, please check the security settings in the IE browser.
 - a. IE → Tools → Internet Options... → Security Tab → Custom Level... → Security Settings → Download unsigned ActiveX controls → Select **Enable** or **Prompt**.
 - b. IE → Tools → Internet Options... → Security Tab → Custom Level... → Initialize and script ActiveX controls not marked as safe → Select **Enable** or **Prompt**.

1



2

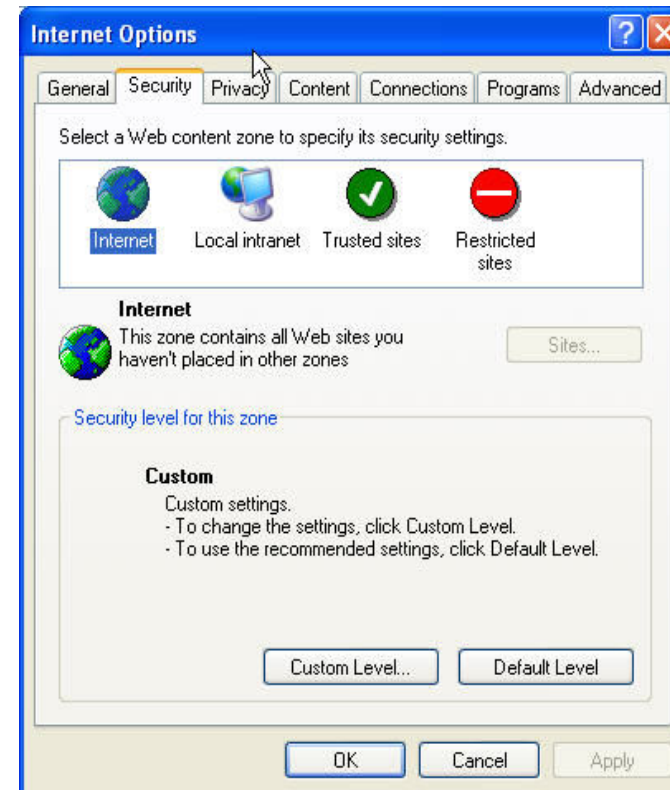

3

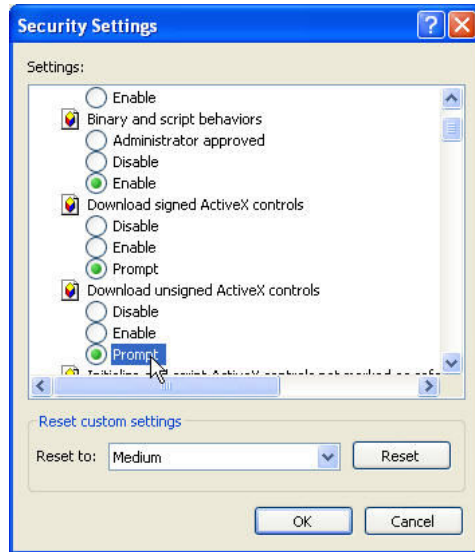

4

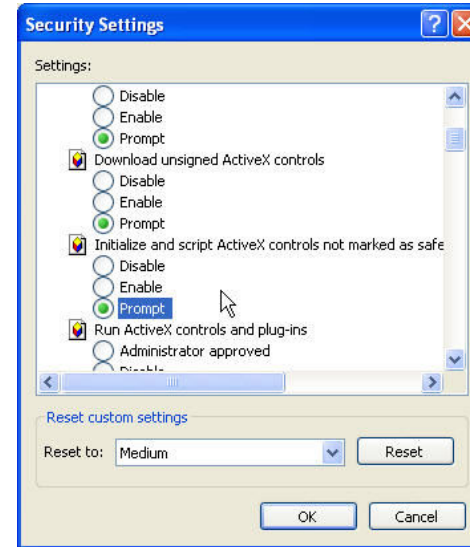

5

When popup the following dialogue box, click "Yes".

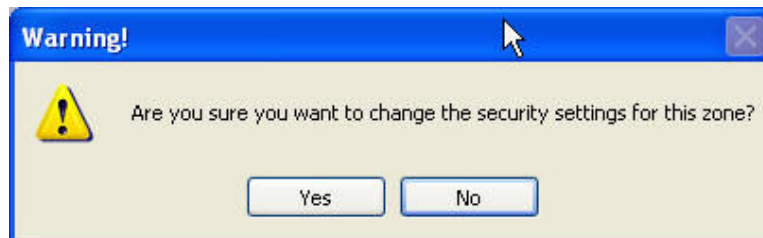

2. You can choose another way:

Go to: IE→Tools → Internet Options... → Security Tab → Trusted sites → Add the IP address and click **OK**.

In the site list you can key one single IP address or a LAN address. For example, if you add **192.168.21.***, all the IP address under **21.*** on the LAN will be regarded as trusted sites.

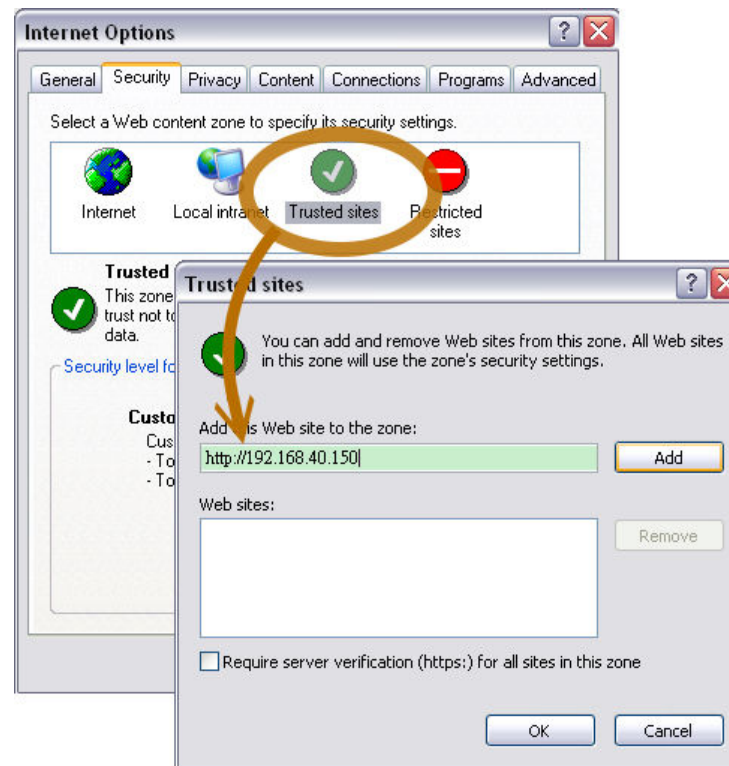

2. To Non-IE Web Browser Users

If you use Firefox or Google chrome to access the IP camera but fails to watch the live video, please follow the steps to install necessary tools:

(The following pictures are based on chrome.)

a. You may see the prompt message as the picture below. Click the link:

Firstly, please install Microsoft Visual C++ 2010 Redistributable Package (x86).

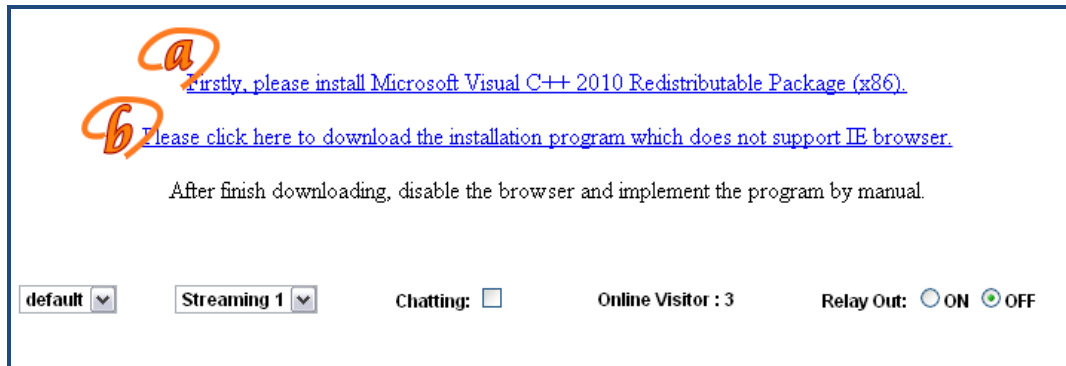

The link will conduct you to the Microsoft official site where you can download the tools. Please select the language and click **download**.

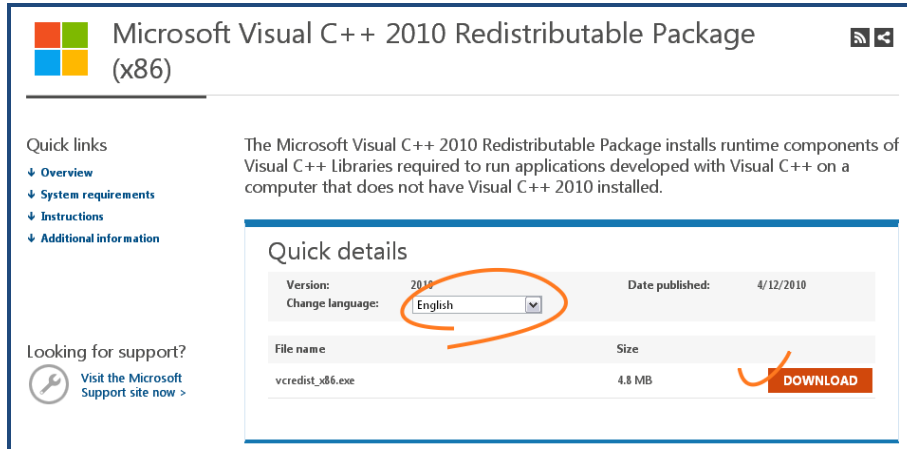

In the pop-up window, please tick the first and the third file as the picture below. Click **Next** to download both **Microsoft .NET Framework 4 Client Profile (Web Installer)** and **Microsoft Visual C++ 2010 Redistributable Package (x64)**.

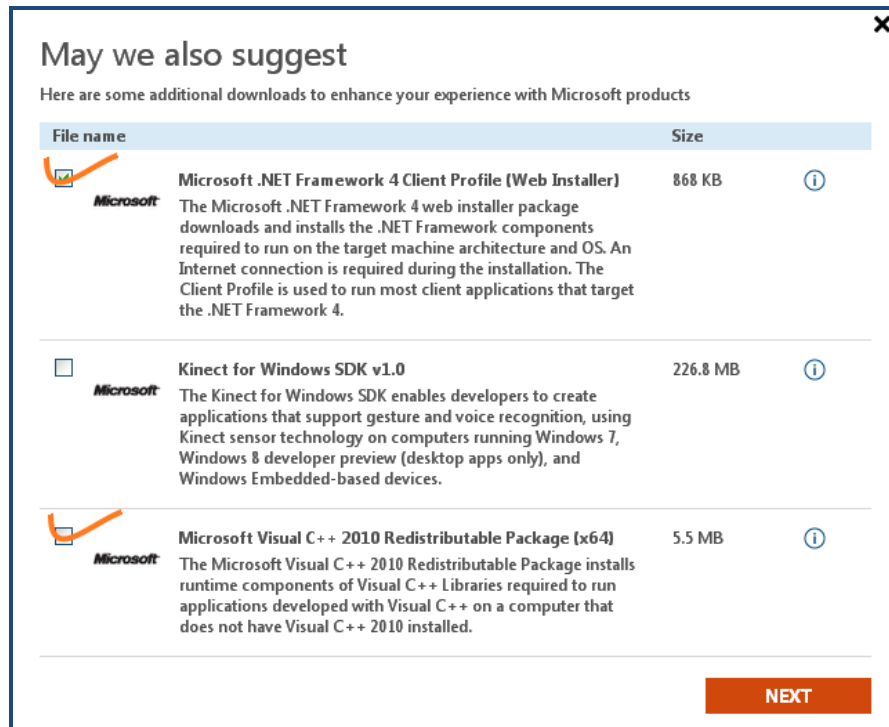

After finishing downloading, execute the two files respectively to install them. The windows may ask you to reboot the PC when the installation is finished.



b. Then, click the second link **Please click here to download the installation program which does not support IE browser** to download Setup ActiveX.

After finishing downloading, execute the files to install **ActiveX**. Then restart the browser.

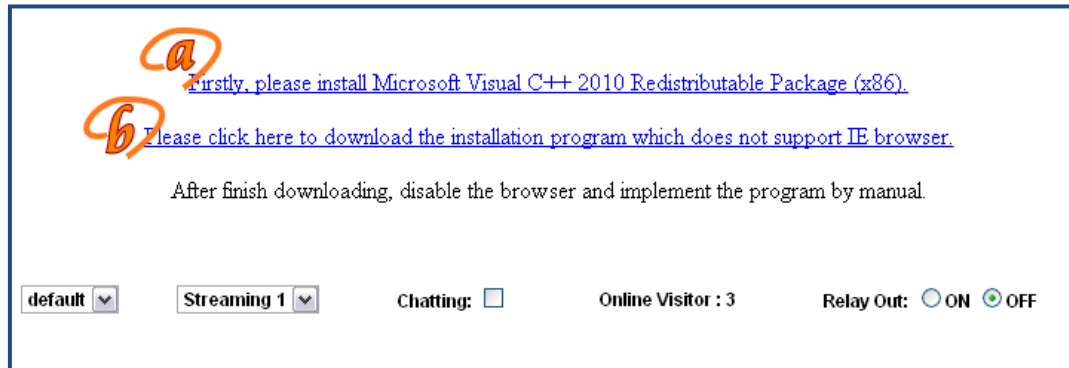
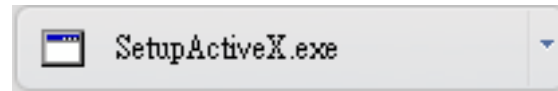

c. If you execute the steps above but still cannot see live video normally, please try the following solution:

Search for the file **np_hoem_x.dll** in your system disk. For Windows XP users, please go to **Start** → **Search** → Search for **All files and folders** and key-in **np_hoem_x.dll**. For Windows 7 users, please use the search bar on the top-right of the Windows Explorer.

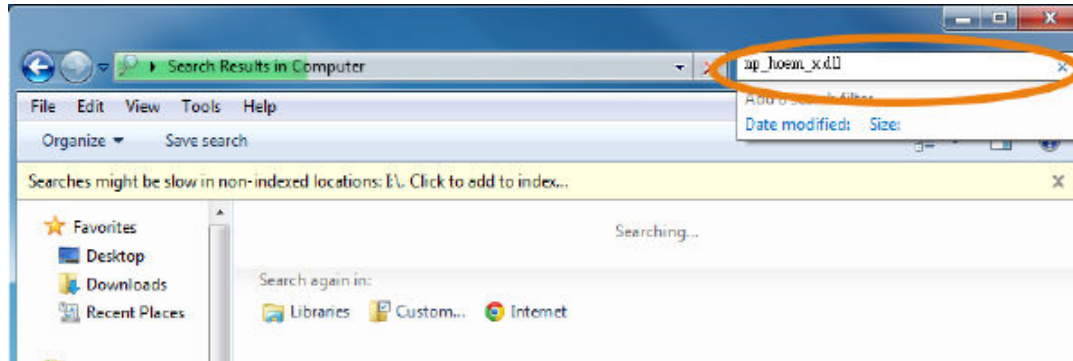

Delete all the files named **np_hoem_x.dll**. They're the **ActiveX** control tools installed in your computer, but the old version of **ActiveX** might not be compatible with the new version of the browser. Therefore, they need to be deleted in order to install the latest **ActiveX** control.

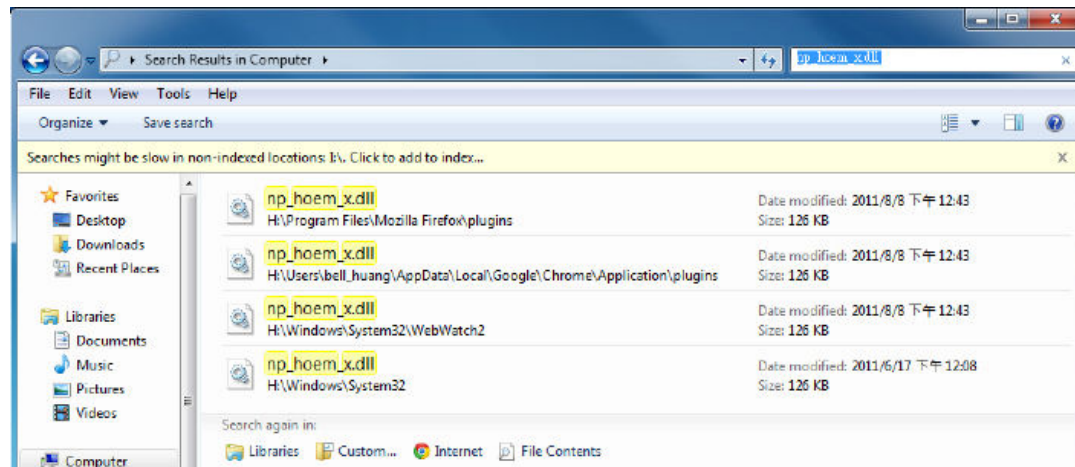

Start your web browser, and repeat the step 2-b: **Download the installation program which does not support IE browser** to download and install **ActiveX**.

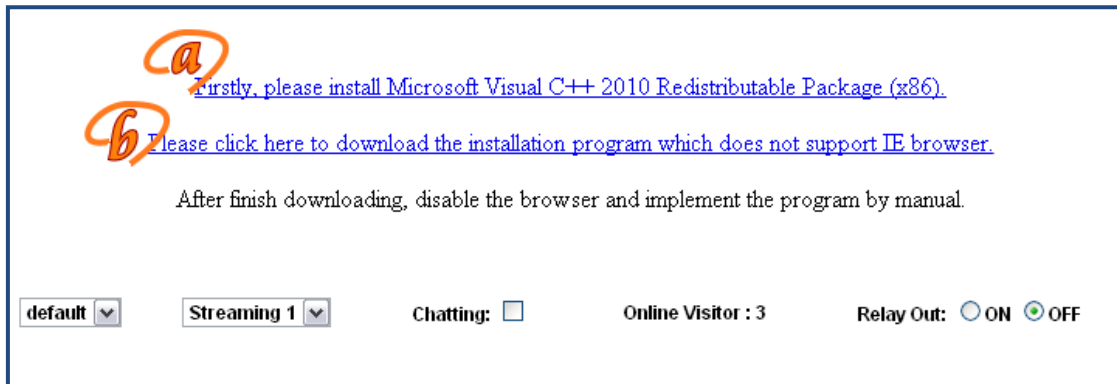

a) [Firstly, please install Microsoft Visual C++ 2010 Redistributable Package \(x86\).](#)

b) [Please click here to download the installation program which does not support IE browser.](#)

After finish downloading, disable the browser and implement the program by manual.

default ▼ Streaming 1 ▼ Chatting: Online Visitor : 3 Relay Out: ON OFF

Chapter 4. Live Video

Start an IE browser, type the IP address of the IP camera in the address field. It will show the following dialogue box. Key-in the user name: **admin** and password: **admin**.

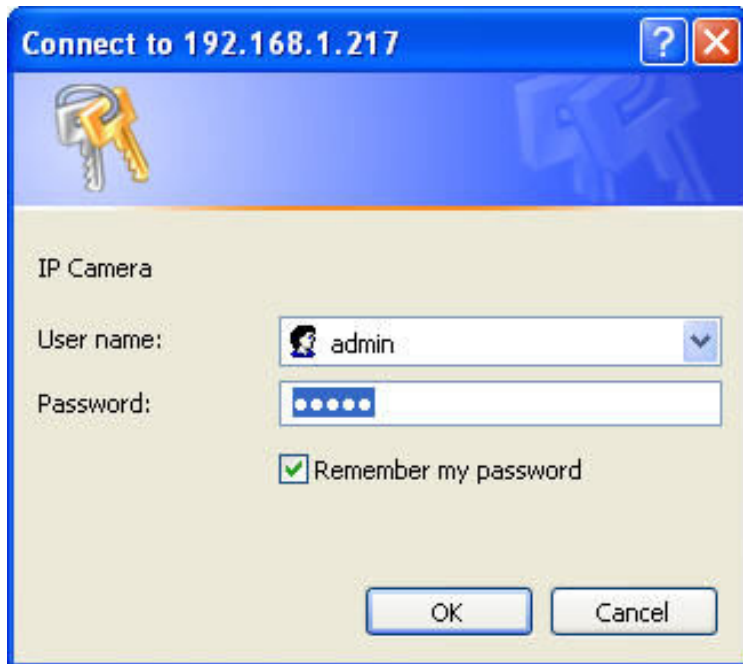

When the IP Camera is successfully connected it shows the following interface.

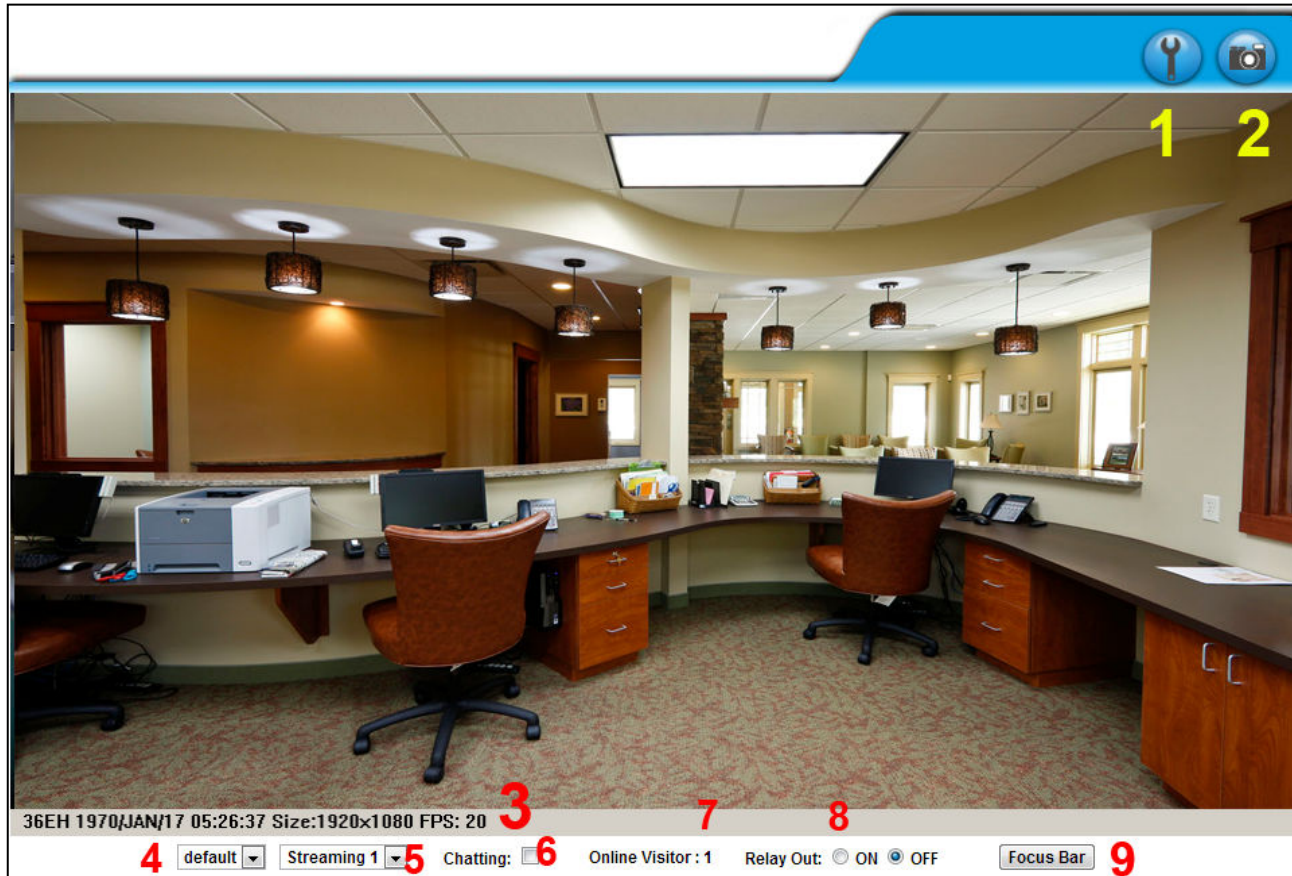

1. Get into the administration page.
2. Video Snapshot.
3. Show the system time, video resolution, and video refreshing rate.
4. Adjust image: 1/2x, 1x, 2x.
5. Streaming source: If the streaming 2 is closed, this function will not be displayed.
6. Tick on **Chatting** for enabling two-way audio.
7. Shows how many people are connected to this IP camera.
8. Control the relay output connected to this camera.
9. Focus bar: It will display a focus bar in the top-left corner, on the live video image for 3 minutes. The bar will be displayed as full if the camera is totally focused towards the objective.

Double-clicking on the video will change the view to full screen mode. Press **Esc** or double-click the video again for changing back to normal mode.

Right-Click the mouse on the video, it will show a pop-up menu.

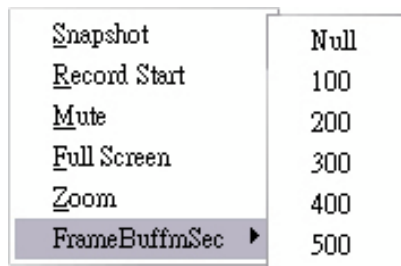

S <u>n</u> APSHOT	Null
R <u>e</u> CORD S <u>T</u> ART	100
M <u>U</u> TE	200
F <u>U</u> LL S <u>C</u> REEN	300
Z <u>U</u> OM	400
F <u>R</u> AMEB <u>U</u> FFM <u>S</u> EC	500

1. Snapshot: Save a JPEG picture.
2. Record Start: Record the video in the local PC. It will ask where to save the video. To stop recording, right-click again and Select **Record Stop**.
(The video format is AVI. Use Microsoft Media Player to play the recorded file.)
3. Mute: Turn-off the audio. Click again to turn on it.
4. Full Screen: Full-screen mode.
5. Zoom: Enable the zoom-in and zoom-out functions. First, select **Enable digital zoom** option within the pop-up dialogue box and then drag and drop the bar to adjust the zoom factors.

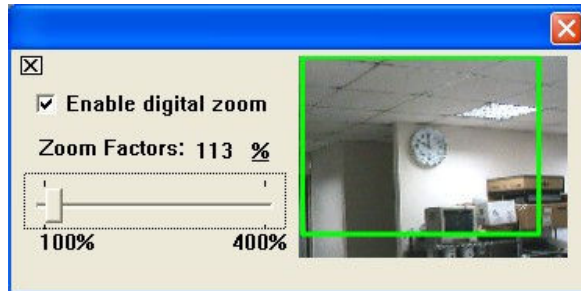

6. Frame Buffm Sec: This function builds a temporary buffm to accumulate several video frames. This function can make video smooth-going when the Network speed is slow and lag. If you select **100**, the camera plays video 100 mSec after receiving images from camera. The slower the Network is the bigger value should be selected. The available values are: **NULL, 100, 200, 300, 400, and 500**. The default value is null.

Chapter 5. Camera Configuration



Click



to go back to the live video page.

5.1. System

I. System Information

a. Server Information: Set up the camera name, select language, and set up the camera time.

1. Server Name: This is the Camera name. This name will be shown on the IP Installer.

2. Select language: English, Traditional Chinese, and Simplified Chinese can be selected. When it changes, it will show the following dialogue box to confirm the language changing.



b. OSD Setting: Select a position where the date & time stamp / text are shown on the screen.

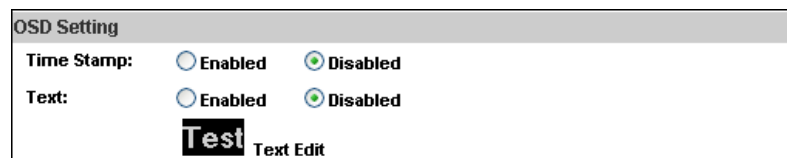

Moreover, click **Text Edit** for changing the OSD content, including text size and alpha. Finally, click the **Upgrade** button to keep the settings.

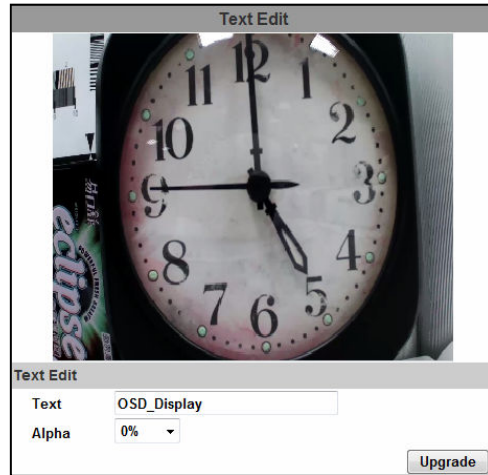

- c. Server time setting: Select between the options **NTP**, **Synchronize with PC's time**, **Manual**, **The date and time remain the same** for setting the time.

Time Setting

Server Time: 2011/11/28 18:48:45 Time Zone: GMT+08:00

Date Format: yy/mm/dd mm/dd/yy dd/mm/yy

Time Zone:

Enable Daylight Saving:

	Month	Week	Day of Week	Time
DST Start:	<input type="text" value="Mar"/>	<input type="text" value="2nd"/>	<input type="text" value="Sun"/>	<input type="text" value="12 am"/>
DST End:	<input type="text" value="Nov"/>	<input type="text" value="1st"/>	<input type="text" value="Sat"/>	<input type="text" value="12 am"/>

NTP :

NTP Server :

Update : Hour

Time Shift : Minutes [-1440..1440]

Synchronize with PC's time

Date :

Time :

Manual

Date :

Time :

The date and time remain the same

II. User Management

The IP Camera supports three different users: **administrator**, **general**, and **anonymous** user.

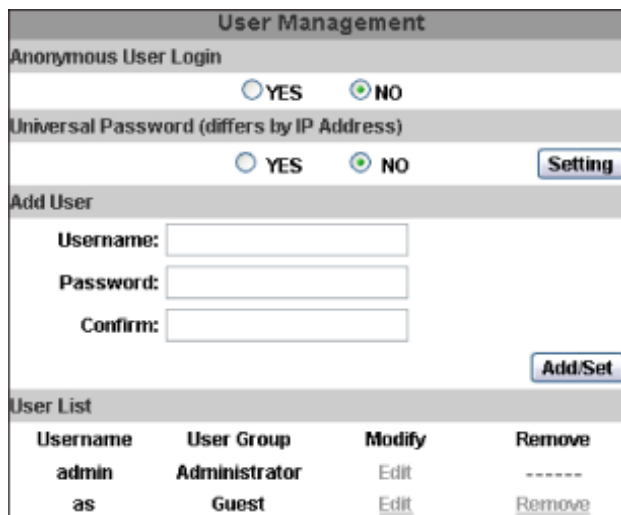

The screenshot shows the 'User Management' web interface. It contains several sections: 'Anonymous User Login' with radio buttons for YES and NO (NO is selected); 'Universal Password (differs by IP Address)' with radio buttons for YES and NO (NO is selected) and a 'Setting' button; 'Add User' with input fields for Username, Password, and Confirm, and an 'Add/Set' button; and 'User List' which is a table with columns for Username, User Group, Modify, and Remove.

Username	User Group	Modify	Remove
admin	Administrator	Edit	-----
as	Guest	Edit	Remove

a. Anonymous User Login:

Select **Yes** for allowing everybody to watch live video without username and password. However, if you try to enter the configuration page the camera will ask you to key-in the username and password.

Select **No** for requiring a username and login to access the camera.

b. Universal Password:

Select **Yes** for allowing login to this IP Cam by universal password. Please refer to **Universal Password** chapter for more explanations. Select **No** for disabling universal password.

c. Add user

Type the user name and password, then click **Add/Set**. The guest user can only browse live video page and is not allowed to enter the configuration page.

d. Click “edit” or “delete” in the user list to modify them. The system will ask you to key-in the password in the pop-up window before you edit the user information.

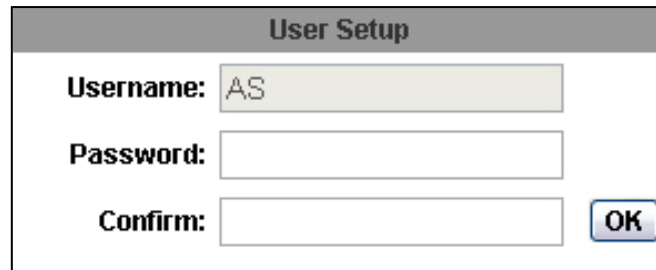

The image shows a 'User Setup' dialog box with a grey title bar. It contains three input fields: 'Username:' with the text 'AS', 'Password:', and 'Confirm:'. An 'OK' button is located to the right of the 'Confirm:' field.

III. System update

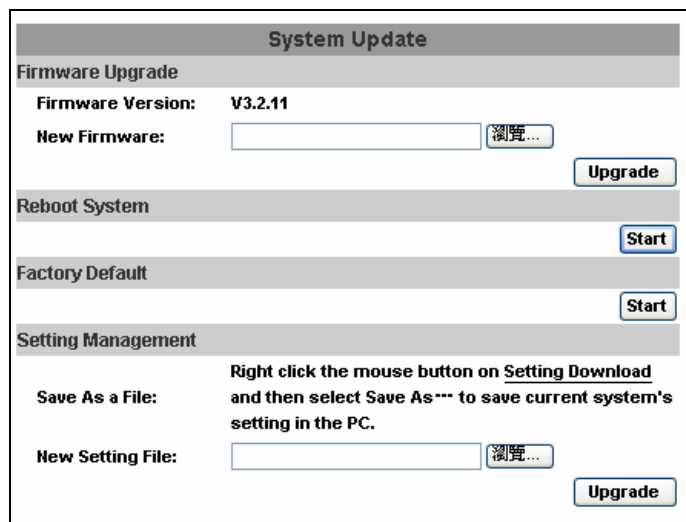

The screenshot shows a web interface titled "System Update". It is divided into four main sections: "Firmware Upgrade", "Reboot System", "Factory Default", and "Setting Management".

- Firmware Upgrade:** Shows the current "Firmware Version" as V3.2.11. There is a "New Firmware:" field with a "浏览..." (Browse...) button and an "Upgrade" button.
- Reboot System:** Features a "Start" button.
- Factory Default:** Features a "Start" button.
- Setting Management:** Includes a "Save As a File:" section with instructions: "Right click the mouse button on Setting Download and then select Save As... to save current system's setting in the PC." Below this is a "New Setting File:" field with a "浏览..." (Browse...) button and an "Upgrade" button.

- a. To update the firmware online, click **Browse...** to select the firmware. Then click **Upgrade** to proceed.
- b. Reboot system: re-start the IP camera
- c. Factory default: delete all the settings of this IP camera.
- d. Setting Management: The user can download the current settings to PC, or upgrade from previous saved settings.
 1. Settings download:
Right-click the mouse button on Setting Download → Select **Save AS...** to save current IP Camera settings in PC → Select saving directory → Save
 2. Upgrade from previous settings
Browse → search previous settings → open → upgrade → Settings update confirm → click index.html. for returning to the main page

5.2. Network

Advanced IP Settings

The IP Camera supports DHCP and static IP

IP Setting	
IP Assignment	
<input type="radio"/> DHCP	
<input checked="" type="radio"/> Static	
IP Address:	<input type="text" value="192.168.1.200"/>
Subnet Mask:	<input type="text" value="255.255.255.0"/>
Gateway:	<input type="text" value="192.168.1.254"/>
DNS 0:	<input type="text" value="168.95.1.1"/>
DNS 1:	<input type="text" value="168.95.192.1"/>

- DHCP: The IP Camera will get all the network parameters automatically.
- Static IP: Type-in the IP address subnet mask, gateway, and DNS.

IPv6 Assignment

IPv6 Assignment

IPv6 Enabled:

Manually setup the IPv6 address:

IPv6 Address/Prefix: /

IPv6 Gateway:

IPv6 DNS:

DHCPv6: Enabled Disabled

IPv6 Address:
fe80::20f:dff:fe00:284d

By enabling DHCPv6 you can configure the following IPv6 address settings:

- ✓ Manually setup the IPv6 address: Key-in the Address, Gateway, and DNS.
- ✓ DHCPv6: If you have a DHCPv6 server, enable it to assign the IPv6 automatically. The assigned IP address will be displayed beside the column.
- ✓ Automatically generated IPv6 Address: Indicates a virtual IPv6 address generated automatically by the IP camera. This virtual IPv6 address cannot be used on WAN.

To use IPv6 address to access the IP camera, open the web browser, and key-in the **[IPv6 address]** in the address bar. The [] parentheses mark is necessary

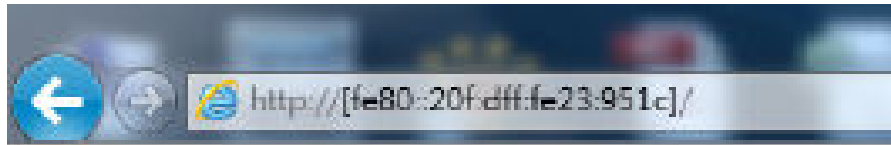

- a. Port Assignment: The user might need to assign a different port to avoid conflicts when setting up the IP.

Port Assignment	
Web Page Port:	<input type="text" value="80"/>
HTTPS Port:	<input type="text" value="443"/> HTTPS Setting

- b. Web Page Port: setup the web page connecting port and video transmitting port (Default: 80)
 c. HTTPs Port: setup the https port(Default: 443)

UPnP

UPnP	
UPnP:	<input checked="" type="radio"/> Enabled <input type="radio"/> Disabled
UPnP Port Forwarding:	<input type="radio"/> Enabled <input checked="" type="radio"/> Disabled
External Web Port:	<input type="text" value="80"/>
External HTTPS Port:	<input type="text" value="443"/>
External RTSP Port:	<input type="text" value="554"/>

This IP camera supports UPnP, if this service is enabled on your computer, the camera will automatically be detected and a new icon will be added to **My Network Places**.

UPnP Port Forwarding : Enable UPnP Port Forwarding for accessing the IP Camera from the Internet; this option allows the IP Camera to open ports on the router automatically so that video streams can be sent out from a LAN. There are three external ports for being set: **Web Port**, **Http Port** and **RTSP** port. To utilize of this feature, make sure that your router supports **UPnP** and is activated.

***Note:** UPnP must be enabled on your computer.*

**Please follow the procedure to activate UPnP:

Approach 1

1. Open the **Control Panel** from the **Start Menu**
2. Select **Add/Remove Programs**
3. Select **Add/Remove Windows Components** and open **Networking Services** section
4. Click **Details** and select **UPnP** to setup the service
5. The IP device icon will be added to **My Network Places**
6. The user may double click the IP device icon to access IE browser

Approach 2

1. Open My **Network Space**.
2. Click **Show icons for networked UPnP devices** in the tasks column on the left of the page.
3. Windows might ask your confirmation for enabling the components. Click **Yes**.

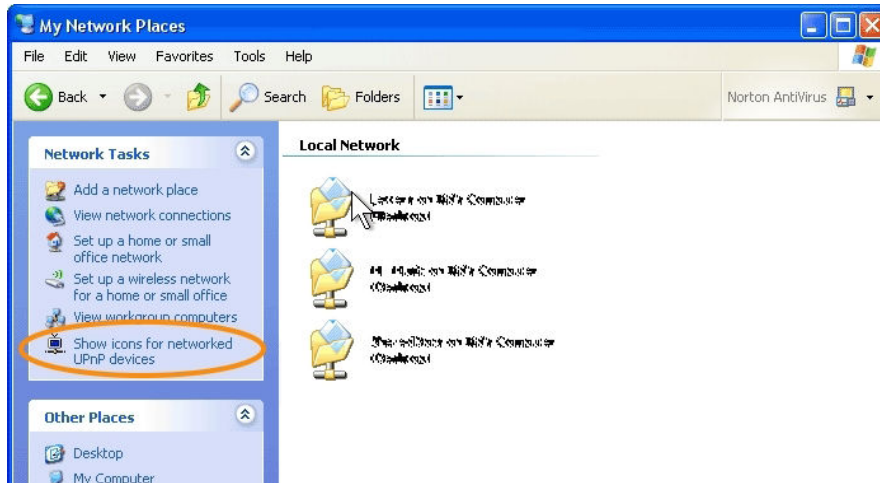

4. Now the IP device is displayed under the LAN. Double-click the icon to access the camera via web browser. To disable the UPnP, click **Hide icons for networked UPnP devices** in the tasks column.

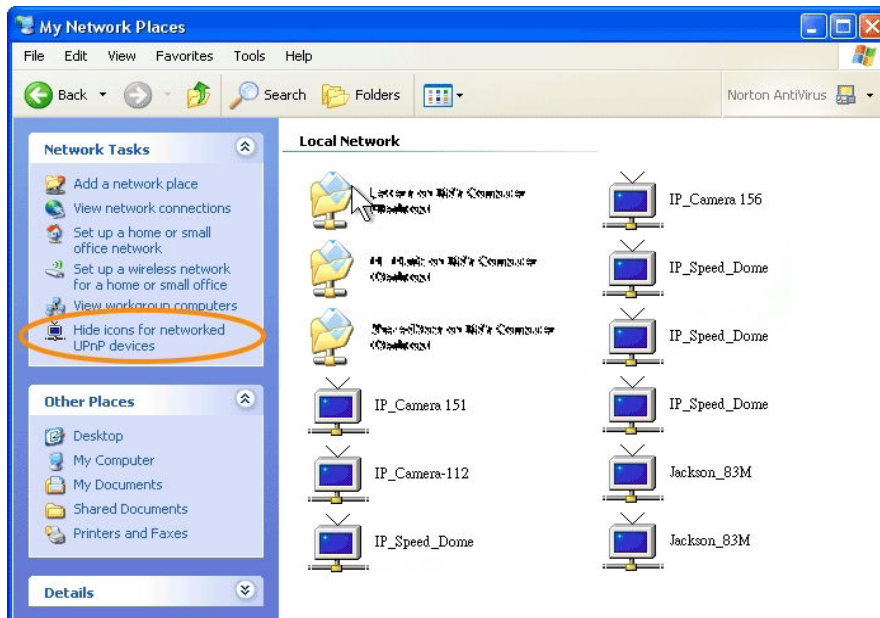

RTSP setting

RTSP Setting		
RTSP Server:	<input checked="" type="radio"/> Enabled	<input type="radio"/> Disabled
RTSP Authentication:	Disable ▾	
RTSP Port :	554	
RTP Start Port:	5000	[1024..9997]
RTP End port:	9000	[1027..10000]

If you have a media player that supports RTSP protocol, you can use it to receive video streaming from the IP camera. The RTSP address can be set for two streamings respectively.

1. RTSP Server: enable or disable

- ✓ **Disable** means everyone who knows your camera IP Address can link to your camera via RTSP. No username and password are required.
- ✓ Under **Basic** and **Digest** authentication mode, the camera asks for a username and password before allows access.
- ✓ The password is transmitted as a clear text under basic mode, which provides a lower level of security than under **digest** mode.
- ✓ Make sure your media player supports the authentication schemes.

2. RTSP Port: setup port for RTSP transmitting (Default: 554)

3. RTP Start and End Port: in RTSP mode, you can use TCP and UDP for connecting. TCP connection uses RTSP Port (554). UDP connection uses RTP Start and End Port

Multicast Setting (Based on the RTSP Server)

Multicast Setting (Based on the RTSP Server)		
Streaming 1:		
IP Address:	<input type="text" value="234.5.6.78"/>	[224.3.1.0 ~ 239.255.255.255]
Port:	<input type="text" value="6000"/>	[1 ~ 65535]
TTL:	<input type="text" value="15"/>	[1 ~ 255]
Streaming 2:		
IP Address:	<input type="text" value="234.5.6.79"/>	[224.3.1.0 ~ 239.255.255.255]
Port:	<input type="text" value="6001"/>	[1 ~ 65535]
TTL:	<input type="text" value="15"/>	[1 ~ 255]

- ✓ Multicast is a bandwidth conservation technology. This function allows several users to share the same packet sent from the IP camera.
- ✓ For using Multicast, appoint here an IP Address and port. TTL means the life time of packet, the larger the value is, the more users can receive the packet.
- ✓ For using Multicast, be sure to enable the function **Force Multicast RTP via RTSP** in your media player. Then key in the RTSP path of your camera: **rtsp ://(IP address)/** to receive the multicast.

ONVIF

ONVIF		
ONVIF:	<input checked="" type="radio"/> v2.10/v1.02	<input type="radio"/> v1.01 <input type="radio"/> Disabled
Security:	<input type="radio"/> Enabled	<input checked="" type="radio"/> Disabled
RTSP Keepalive:	<input checked="" type="radio"/> Enabled	<input type="radio"/> Disabled

1. Choose your ONVIF version and settings

Under ONVIF connection, the video will be transmitted by RTSP. Be sure to enable the RTSP server in IP setting, otherwise the IP Camera will not be able to receive the video via ONVIF.

2. Security

By selecting **Disable**, the username and password are not required for accessing the camera via ONVIF. By selecting **Enable** the username and password are necessary.

3. RTSP Keepalive:

When the function is enabled, the camera checks once in a while if the user who is connected to the camera via ONVIF is still connected. If the connection has been broken the camera will stop transmitting video to the user

Bonjour

Bonjour	
Bonjour:	<input type="radio"/> Enabled <input checked="" type="radio"/> Disabled
Bonjour Name:	<input type="text" value="IP_Camera"/> @00:0F:0D:00:28:4D

- ✓ This function allows Apple systems to connect to this IP camera. On **Bonjour Name** key-in the name here
- ✓ The web browser **Safari** also has a Bonjour function. Tick **Include Bonjour** in the bookmark setting, for the IP camera to appear under the Bonjour category. Click the icon to connect to the IP camera

- ✓ The Bonjour function on Safari browser doesn't support HTTPS protocol. If on the camera you select **https**, the camera will appear on Safari's bookmarks but it cannot be accessed
- ✓ Take as a reference the following image:

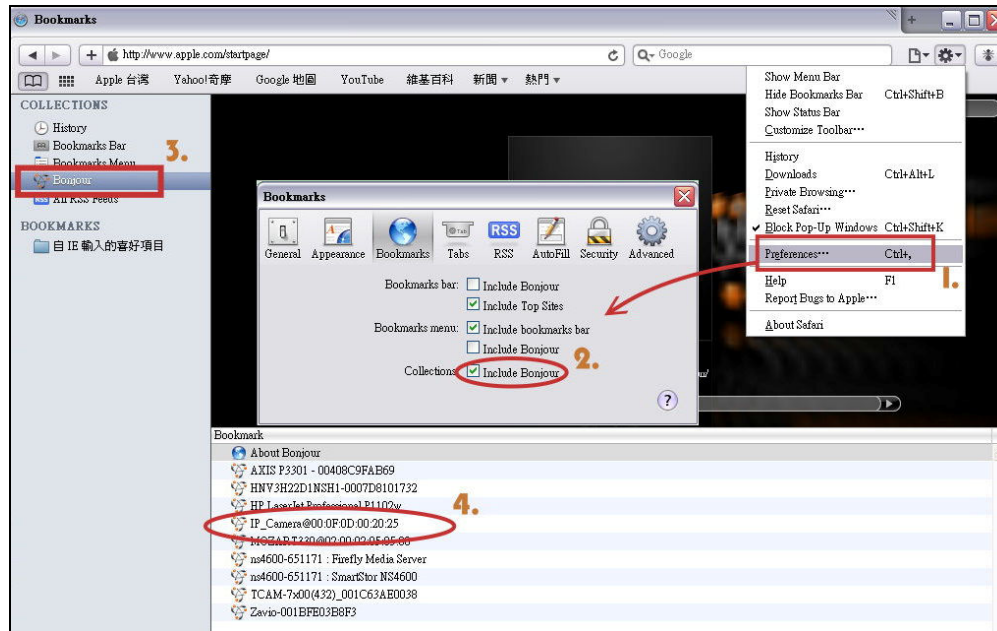

LLTD

LLTD (Link Layer Topology Discovery)

LLTD: Enabled Disabled

- ✓ If your PC supports LLTD, enable this function for allowing checking the connection status, properties, and device location (IP address) in the network map.
- ✓ If the computer is running Windows Vista or Windows 7, you can find LLTD through the path:

Control Panel → Network and Internet → Network and Sharing Center → Click **See full map**

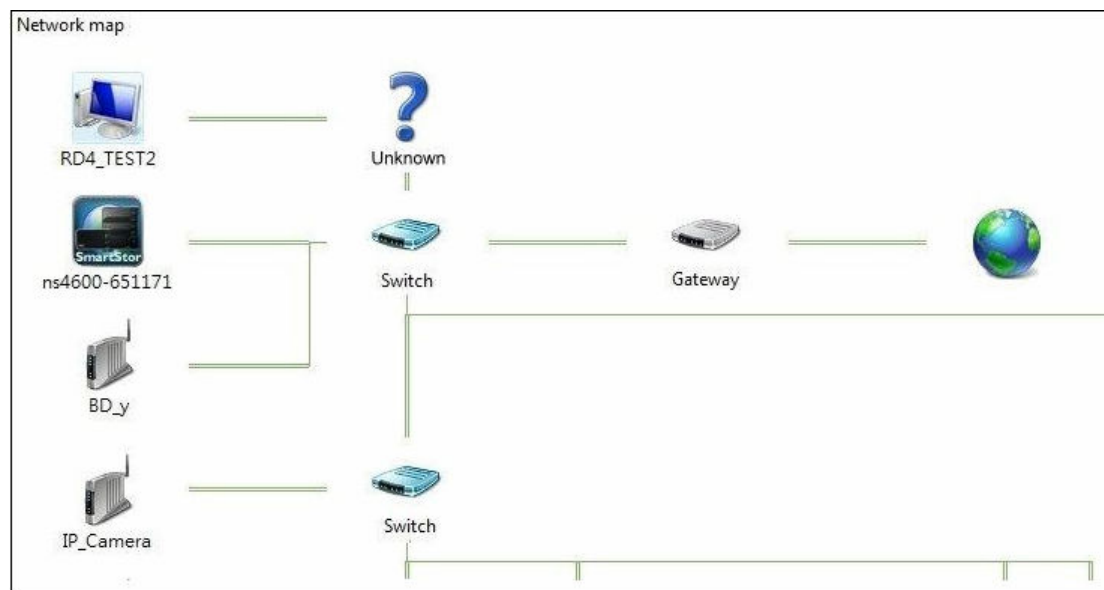

II. Advanced

a. Https (Hypertext Transfer Protocol Secure

When the users access cameras via Https protocol, the transmitted information will be encrypted, increasing the security level.

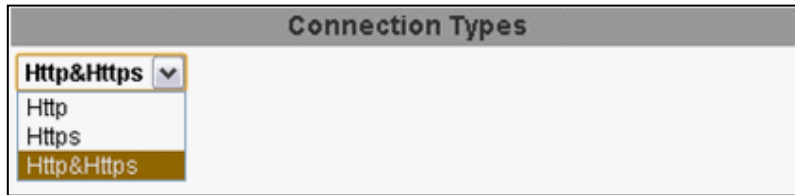

Select the connection type:

- ✓ Http: the user can access the camera via the Http path but cannot access it via the Https path.
- ✓ Https: the user can access the camera via the Https path but cannot access it via the Http path.
- ✓ Http & Https: Both the Http and Https path can be used to access the camera. When you change the connection type settings, it may cause connection error or disconnection error if you switch the protocol directly. Therefore, **Http & Https** mode is necessary.

If you want to change from Http to Https, please switch to **Http & Https** mode first, and then switch to **Https** mode and vice versa.

The Https protocol has a verifying mechanism. When the user access a website via Https, the browser will check the certificate of that domain and verify its trustiness and security.

Certificate generation process:

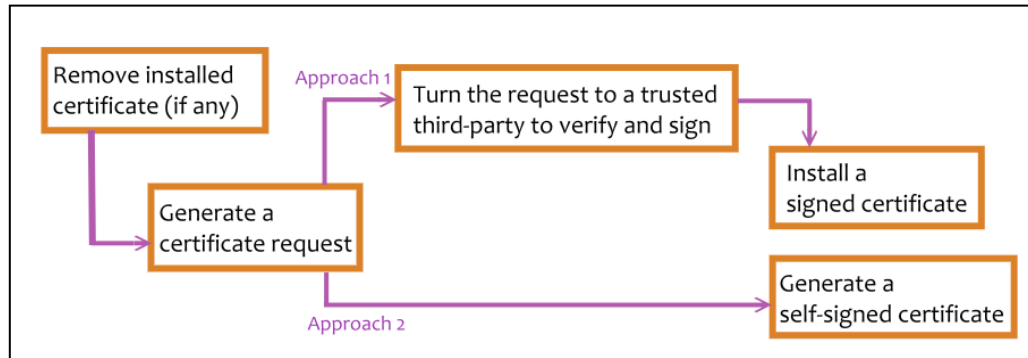

Remove the existing certificate: Before you generate a new certificate, please remove the installed one. Select the **Http** connection type and click **Remove**. If a dialog box pops up to ask you to confirm, click **Yes**.

Created Request: Fill-in the following form and click **apply**.

Https Setting

Create Request

Country:

State or province:

Locality:

Organization:

Organizational Unit:

Common Name:

After generating a certificate request, if you choose to turn it and verified by a trusted third-party, click **Content** and copy all the request content.

<div style="background-color: #cccccc; padding: 2px;">Created Request</div> <p>Subject: C=TW, ST=, L=, O=, OU=, CN=</p> <p>Date: 2012/Sep/25 08:49:23</p> <p style="text-align: center;"> <input type="button" value="Content"/> <input type="button" value="Remove"/> </p>	<p>Certificate Request:</p> <p>Data:</p> <p>Version: 0 (0x0)</p> <p>Subject: C=TW</p> <p>Subject Public Key Info:</p> <p>Public Key Algorithm: rsaEncryption</p> <p>Public-Key: (1024 bit)</p> <p>Modulus:</p> <pre>00:b8:cb:17:f7:b6:14:5d:92:99:ae:73:52:7c 09:2a:ad:a6:50:39:5a:3c:09:10:15:85:ad:30 ce:e0:b2:7c:29:3e:d1:e7:15:c4:f2:4f:de:a6 98:f8:71:53:a3:43:0b:2c:1a:20:94:32:76:b3 72:c8:bc:87:35:3f:c7:fc:17:8f:c3:1f:2d:ak 33:3c:9a:28:3b:31:46:d8:c7:26:37:af:fb:5e aa:b0:a1:75:6a:f9:02:ca:c9:be:49:c9:2a:74 cb:b0:95:1e:63:89:f6:07:6c:cf:1e:5b:38:4e 29:a8:55:82:92:95:be:74:15</pre> <p>Exponent: 65537 (0x10001)</p> <p>Attributes:</p> <p>a0:00</p> <p>Signature Algorithm: sha1WithRSAEncryption</p> <pre>9b:4c:13:01:cc:10:2a:bc:3c:22:f2:10:e7:48:19:52:98:5e c9:ae:5a:f4:76:cb:7d:f8:6c:21:e3:a5:9b:45:60:2a:ba:73 23:ce:7a:90:9c:90:b5:a7:41:36:2c:c4:f4:34:55:e5:d0:92 9d:32:d3:e4:2b:d1:04:7c:58:9c:64:4d:38:e3:a6:73:a0:a5</pre>
--	---

According to the certificate source, there are two ways to install the certificate:

If you had sent the certificate request for signing and receiving a signed certificate, click **browse** and find the certificate file in your computer. Click **Apply** to install it.

If you choose to generate a self-signed certificate, fill-in the following forms and set the validity day, click **Apply** to finish installed it.



The image shows two stacked dialog boxes. The top one is titled "Install Signed Certificate" and has a "Signed Certificate:" field with a "浏览..." (Browse...) button and an "Apply" button. The bottom one is titled "Create Self-Signed Certificate" and contains several text input fields: "Country:", "State or province:", "Locality:", "Organization:", "Organizational Unit:", "Common Name:", and "Validity:" followed by a "Days" field. There is an "Apply" button at the bottom right of this dialog.

After finishing the installation, click on **Content** to call out and check the certificate content

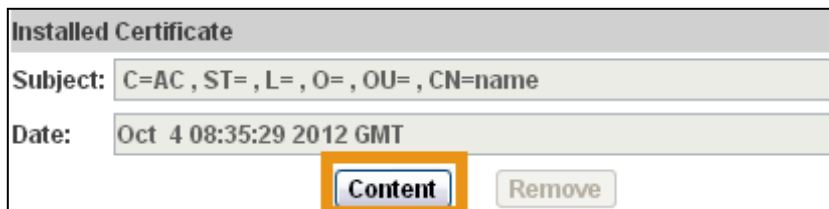

The image shows a dialog box titled "Installed Certificate". It has two text fields: "Subject:" with the value "C=AC , ST= , L= , O= , OU= , CN=name" and "Date:" with the value "Oct 4 08:35:29 2012 GMT". At the bottom, there are two buttons: "Content" (highlighted with an orange border) and "Remove".

To use Https to access the camera, open your browser, and key-in **https:// (IP address)/** in the address bar. Now your data will be transmitted via encrypted communications. The browser will check your certificate status. It might show the following warning message:

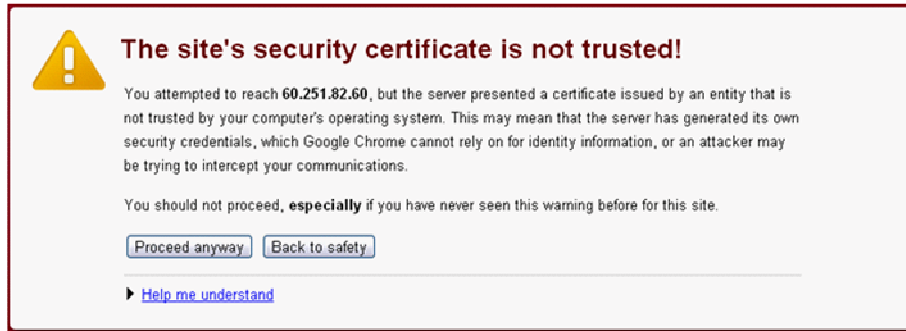

Meaning that certificate is self-signed or signed by a distrusted institution. Click **Proceed anyway** for continuing to the camera page.

b. SNMP (Simple Network Management Protocol)

- 1. SNMPv1 or SNMPv2:** write the name of both **Write Community** and **Read Community**.

SNMP	
SNMP Setting	
<input type="checkbox"/> SNMPv1	<input checked="" type="checkbox"/> SNMPv2c
Write Community:	<input type="text" value="write"/>
Read Community:	<input type="text" value="public"/>

2. **SNMPv3**: Set the Security Name, Authentication Type, Authentication Password, Encryption Type, Encryption Password of Write mode and Read mode

<input checked="" type="checkbox"/> SNMPv3	
Write Security Name:	<input type="text" value="write"/>
Authentication Type:	<input checked="" type="radio"/> MD5 <input type="radio"/> SHA
Authentication Password:	<input type="text" value="....."/>
Encryption Type:	<input checked="" type="radio"/> DES <input type="radio"/> AES
Encryption Password:	<input type="text" value="....."/>
Read Security Name:	<input type="text" value="public"/>
Authentication Type:	<input checked="" type="radio"/> MD5 <input type="radio"/> SHA
Authentication Password:	<input type="text" value="....."/>
Encryption Type:	<input checked="" type="radio"/> DES <input type="radio"/> AES
Encryption Password:	<input type="text" value="....."/>

3. Enable SNMPv1/SNMPv2 Trap for detecting the Trap server

Please set what event needs to be detected.

<input type="checkbox"/> SNMPv1/v2c Trap	
Trap Address:	<input type="text"/>
Trap Community:	<input type="text" value="public"/>
Trap Event:	<input type="checkbox"/> Cold Start <input type="checkbox"/> Warm Start <input type="checkbox"/> Link Up
	<input type="checkbox"/> Authentication Failed <input type="checkbox"/> SD Detect

- ✓ Cold Start: The camera starts up or reboots.
- ✓ Setting changed: The SNMP settings have been changed.
- ✓ Network Disconnected: The network connection was broken down (The camera will send trap messages after the network is connected again).
- ✓ V3 Authentication Failed: A SNMPv3 user account tries to get authentication but failed.(Due to incorrect password or community)
- ✓ SD Insert / Remove: A Micro SD card is inserted or removed.

c. Access list:

Enable IP address filter for setting the IP addresses which allows or denies this camera. There are two options: **single** and **range**.

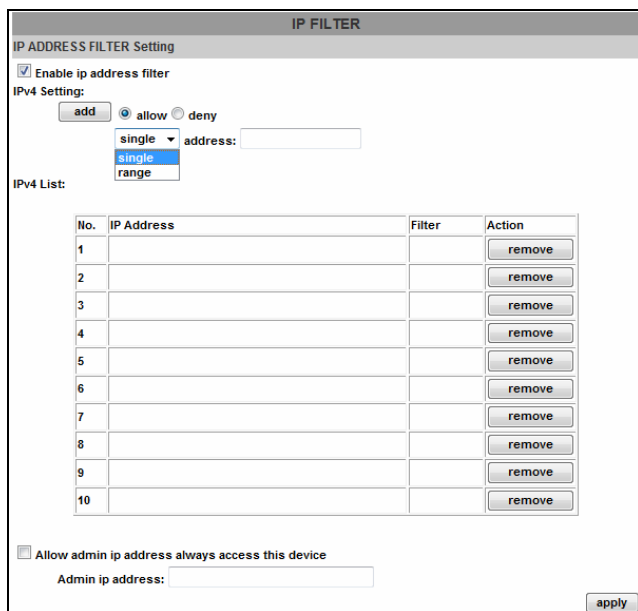

No.	IP Address	Filter	Action
1			remove
2			remove
3			remove
4			remove
5			remove
6			remove
7			remove
8			remove
9			remove
10			remove

d. QoS/DSCP(Quality of Server/Differentiated Services Code-point):

DSCP specifies a simple mechanism for classifying and managing network traffic; and provide QoS on IP networks. DSCP is a 6-bit in the IP header for packet classification purpose. Please define it for **Live Stream, Event / Alarm and Management**

QoS/DSCP

QoS/DSCP Setting

Enable QoS/DSCP

Live Stream: 0 (0-63)

Event / Alarm: 0 (0-63)

Management: 0 (0-63)

Apply

e. IEEE 802.1x:

IEEE 802.1x is an IEEE standard for port-based Network Access Control. It provides an authentication mechanism to a device on a LAN or WLAN.

The EAPOL protocol support service identification and optional point to point encryption over the local LAN segment.

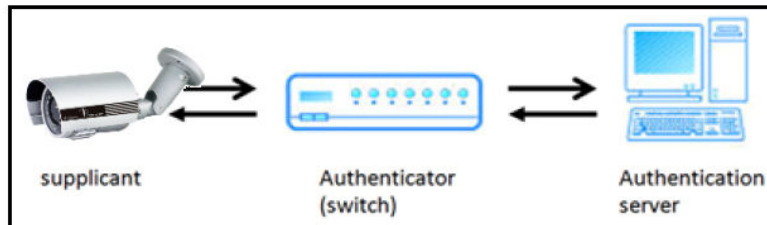

Please check what version of the authenticator and authentication server is supported. This camera supports EAP-TLS method. Please enter the ID, password issued by the CA, then upload related certificates.

IEEE 802.1x/EAP-TLS

IEEE 802.1x Setting

Enable IEEE 802.1x

Eapol version: v1 v2

Identity:

Private key password:

CA certificate:

Status:

Client certificate:

Status:

Client private key:

Status:

III. PPPoE & DDNS

PPPoE

PPPoE Setting

Enabled Disabled

Username:

Password:

Send mail after dialed

Enabled

Subject:

a. **PPPoE:** Select **Enabled** to use PPPoE. Key-in the the Username and password for ADSL connection.

Send mail after dialed: When connected to the internet, the camera will send a mail to a specific mail account.

b. **DDNS (camddns example):**

DDNS

DDNS Setting

Enabled Disabled

Provider: ▼

Username:

Schedule Update: Minutes

State

▲ ▼

Note:

1. Schedule Update: Feature of DDNS schedule update is designed for IP products which installed behind the ICS or NAT devices. Update range from every 5 (minutes) to 5000 (minutes) and 0 remain to off.
2. Please note that the hostname will be blocked by DynDNS.org if schedule update is more than once every 5 minutes to 60 minutes. In general, schedule update in every 1440 minutes is recommended.



1. Enable this service.
2. Key-in the username.
3. IP schedule update. Default: 5 minutes.
4. Click **Apply**.

DDNS Status

1. **Updating:** Information update
2. **Idle:** Stop service.
3. **DDNS registration successful, can now log by <http://<username>.ddns.camddns.com>:** Register successfully.
4. **Update Failed, the name is already registered:** The user name has already been used. Please change it.
5. **Update Failed; please check your internet connection:** Network connection failed.
6. **Update Failed, please check the account information you provided:** The server, user name, and password may be wrong.

IV. Server settings

There are three server types available: **Email**, **FTP** and **SAMBA**. Select the item for display detailed configuration options. You can configure either one or all of them.

To send out the video via mail of FTP, please set up the configuration first.

Server Settings	
Mail Setting	
Login Method:	Account ▾
Mail Server:	<input type="text"/>
Username:	<input type="text"/>
Password:	<input type="password"/>
Sender's Mail:	<input type="text"/>
Receiver's Mail:	<input type="text"/>
Bcc Mail:	<input type="text"/>
Mail Port:	25 (Default 25)
<input type="checkbox"/> Secure Connect:	<input checked="" type="radio"/> TLS <input type="radio"/> SSL
<input type="button" value="Test"/>	
FTP Setting	
Samba (Network storage)	
<input type="button" value="Apply"/>	

FTP

To send out the video via mail of FTP, please set up the configuration.

FTP Setting	
FTP Server:	<input type="text"/>
Username:	<input type="text"/>
Password:	<input type="password"/>
Port:	21
Path:	/
Mode:	PORT ▾
Create the folder:	Yes ▾ (ex:Path/20100115/121032m.avi)
<input type="button" value="Test"/>	

Samba

Select this option to send the media files via a neighbor network when an event is triggered.

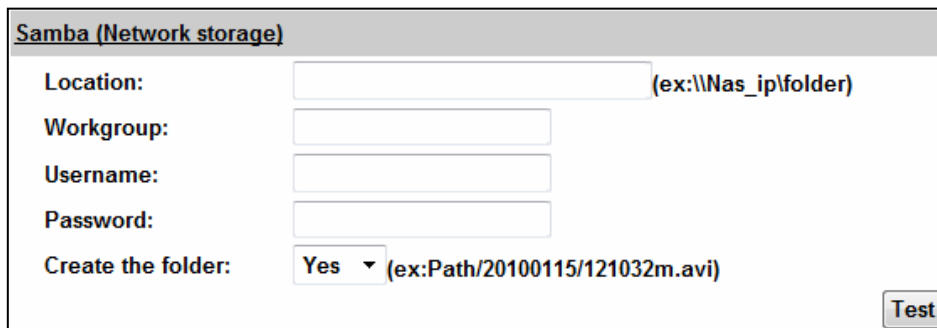

Click **Apply** to save the setting, then use **Test** button to test the server connection. A message box will tell you **OK!** if it works, and a test document will be created in the location.

If the test failed, check the sharing setting of your location folder. The folder properties must be **shared** and the permissions must be **Full Control** as the picture.

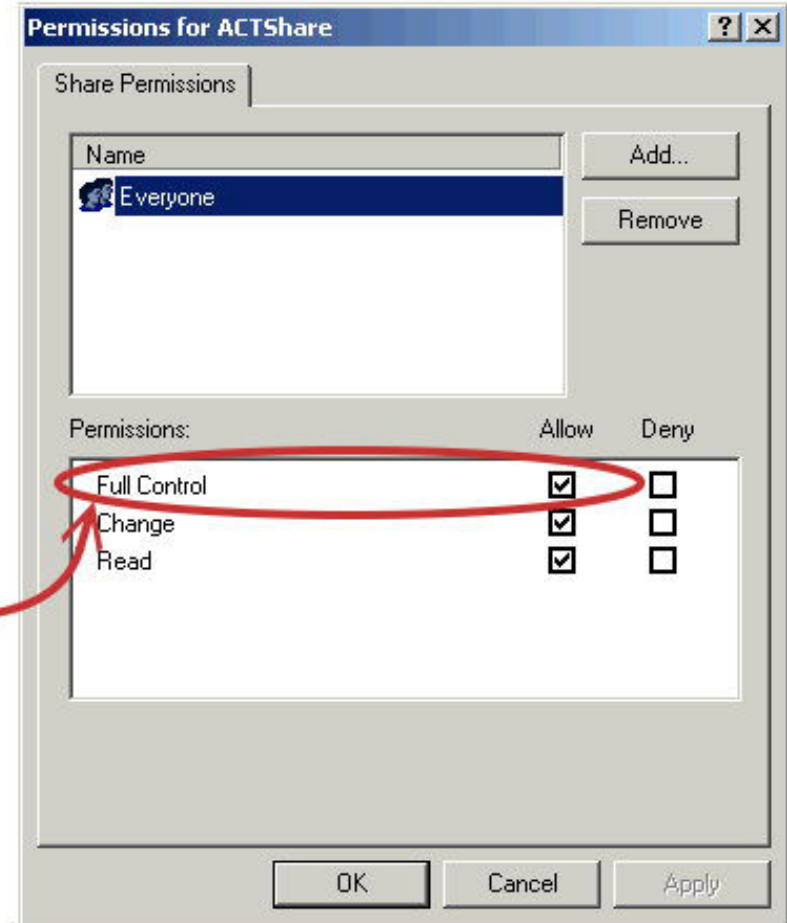
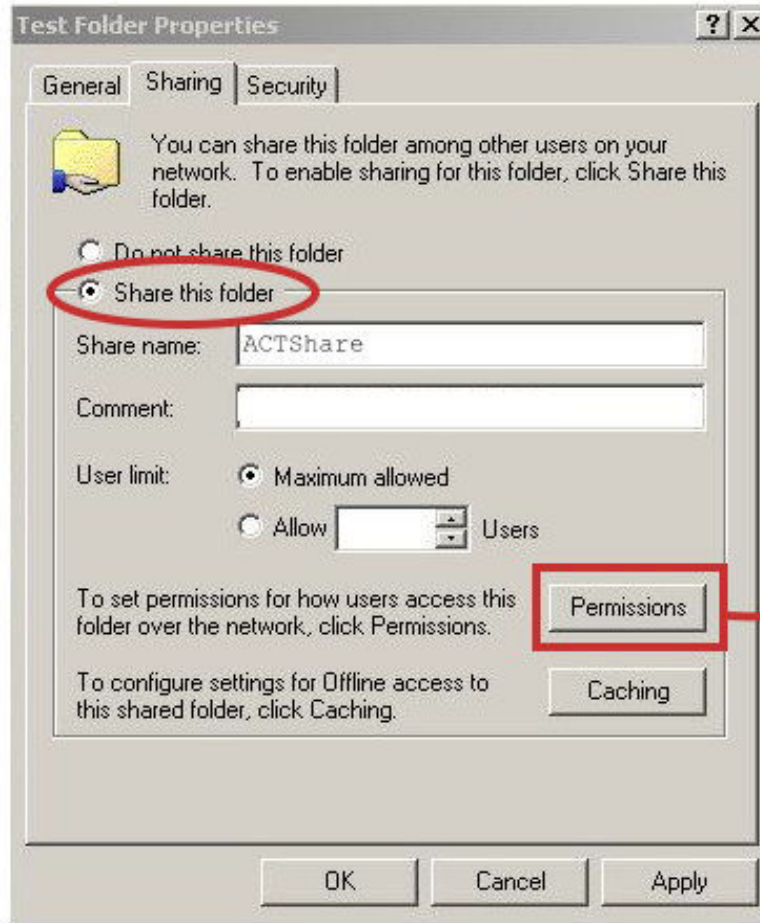

5.3. A / V Setting

1. Image Setting

Please refer to the details below for image settings:

Privacy Mask

Area 1 Area 2 Area 3 Save **a**

Image Setting

Brightness: 0 ▾

Contrast: 0 ▾

Hue: 0 ▾

Saturation: 0 ▾

Sharpness: 0 ▾

AGC: **c** 16x ▾

Shutter Time: **d** Outdoor ▾

Sense-Up: **e** 1/15 ▾

D-WDR: **f** Off ▾

Anti Fog: **g** Enable

Lens Distortion Correction: **h** OFF ▾

Video Orientation: **i** Flip Mirror

Day & Night: Light Sensor Mode ▾

Night to Day Lux: **j** 7 lux ▾ (about) Day to Night Lux: 3 lux ▾ (about)

Current Lux: over 55 lux (about)

Red Gain: **k** 0 ▾ Blue Gain: 0 ▾

Denoise: **l** 3D: 5 ▾ 2D: 1 ▾ Default



NC-22BC 2 Megapixels IR IP Camera User's Manual Ver.A2

- a. For security and privacy purposes, there are three areas that can be set up for privacy. Click the Area button first, and then drag an area on the above image. Remember to save your settings. The masked area will not be shown on both live view and recording image.

- b. Brightness, Contrast, Hue, Saturation, Sharpness can be adjusted here. The available values are: **-4, -3, -2, -1, 0, 1, 2, 3, 4.**

- c. AGC: The sensitivity of the camera can be adjusted to the environmental lighting. By enabling this function the camera will get brighter images on low light, but the level of noise may also increase. The available values are: **16x, 24x, 32x, 48x, 64x.**

- d. Shutter Time: Choose the location of your camera or a fixed shutter time. The shorter the shutter time is the less light the camera receives and the image becomes darker.

Note: When you select a number in **Shutter Time**, the shutter time will vary in a range and be controlled by camera automatically. The following table shows the shutter time options and corresponding range.

Option	Shutter Time Range (sec.)
Outdoor	1/33000 ~ Selected number in Sense-up
Indoor	NTSC: 1/120 ~ Selected number in Sense-up PAL: 1/100 ~ Selected number in Sense-up
1/30	1/33000 ~ 1/30
1/50	1/33000 ~ 1/50
1/60	1/33000 ~ 1/60
1/100	1/33000 ~ 1/100
1/125	1/33000 ~ 1/125
1/250	1/33000 ~ 1/250
1/500	1/33000 ~ 1/500
1/1000	1/33000 ~ 1/1000
1/33000	1/33000
* Sense-up options: 1/30, 1/15, 1/10, 1/5	

e. Sense-Up: This function increases the sensitivity of camera to get brighter image at night. The smaller the value you select, the slower the shutter speed becomes so that the image will get brighter, and moving subjects might be blurred.

f. D-WDR: This function enables the camera to reduce the contrast in the view to avoid dark zones as a result of over and under exposure. The available values are: **OFF, 1, 2, 3, 4, 5, 6, 7, 8.**

g. Anti Fog: Improve the image clarity on environments presenting high levels of fog or smoke.

h. Lens Distortion Correction: Straight the curves in the borders of the image caused by the lens angles. The available values are: **OFF, 1, 2, 3, 4, 5, 6, 7, 8, 9, 10.**

i. Video Orientation: Flip or mirror the image.

j. Day & Night: The camera can detect the light level of the environment. If you choose **Light Sensor Mode**, the image will be turned black and white at night in order to keep a clear image. To set light sensor mode, appoint a Lux standard for switching D/N.

The current Lux value is provided as a reference. Under **Times Mode** the switch time of Color / Black and white will be according to the given time.

You can also control it by choosing **Color** or **B/W**.

k. Red / Blue gain: Set the values for Red / Blue gain. The available values are: **-5, -4, -3, -2, -1, 0, 1, 2, 3, 4, 5.**

l. Denoise: This function is able to filter the noise and blur from the image and show a clearer view. You can set the values for 2D and 3D filters. The available values are: **OFF, 1, 2, 3, 4, 5, 6, 7, 8, 9.**

2. Video Setting

Video Setting	
Video System:	NTSC ▼
TV Output:	Auto ▼ (Auto : Based on the Video System)
TV Output Focus Bar:	<input checked="" type="radio"/> ON <input type="radio"/> OFF
Corridor Mode:	none ▼

Video System: NTSC or PAL

TV Output: Auto, NTSC or PAL

TV Output Focus Bar: Auto, NTSC or PAL

Corridor Mode: 90 degrees, 270 degrees or none.

Notes:

- ✓ Video Output should be used for Live View only. For recording please use the standard **RJ54** output.
- ✓ Analog cameras are not designed for High Resolution images.

On Corridor Mode please take note of the lens' position. If **Corridor Mode** is set as **none** the relation of the image and the camera would be as the following:

Corridor mode: None

Image	Position
	 <p data-bbox="1016 628 1169 660">0 degrees</p>
	 <p data-bbox="1008 975 1178 1007">90 degrees</p>
	 <p data-bbox="999 1321 1187 1353">270 degrees</p>

Image	Position
	<div data-bbox="750 352 1079 603">  <p data-bbox="824 632 1001 667">90 degrees</p> </div> <div data-bbox="750 697 1079 948">  <p data-bbox="819 976 1005 1011">270 degrees</p> </div>
	<div data-bbox="757 1024 1072 1262">  <p data-bbox="835 1275 992 1310">0 degrees</p> </div>

If Corridor Mode is set as **90 degrees** or **270 degrees** the relation of the image and the camera would be as the following:

Corridor Mode: 90 or 270 degrees

a. Streaming 1 & 2 Basic Mode

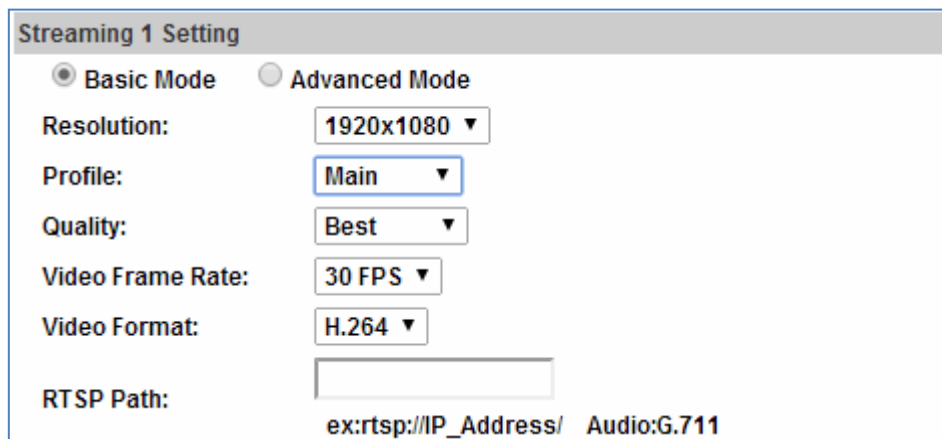

Streaming 1 Setting

Basic Mode Advanced Mode

Resolution: 1920x1080 ▼

Profile: Main ▼

Quality: Best ▼

Video Frame Rate: 30 FPS ▼

Video Format: H.264 ▼

RTSP Path:

ex:rtsp://IP_Address/ Audio:G.711

1. Resolution:
1920x1080@30fps, 1280x720@30fps, 640x480@30fps, 320x240@30fps, 176x144@30fps

2. Profile
Chose between Main or Baseline

3. Quality

There are 5 levels:

Best/ High/ Standard/ Medium/ Low

4. The higher the quality is, the bigger the file size is. Not good for internet transmission.

Video Frame Rate (**5~30 FPS**): The video refreshing rate per second.

5. Video Format: **H.264** or **JPEG**

6. RTSP Path: RTSP output name

b. Streaming 1 & 2 Advanced Mode

Streaming 1 Setting	
<input type="radio"/> Basic Mode	<input checked="" type="radio"/> Advanced Mode
Resolution:	1920x1080 ▾
Profile:	Main ▾
Bitrate Control Mode:	<input checked="" type="radio"/> CBR <input type="radio"/> CVBR
Video Quantitative:	7 ▾
Video Bitrate:	4Mbps ▾
Video Frame Rate:	30 FPS ▾
GOP Size:	1 X FPS ▾ GOP = 30
Video Format:	H.264 ▾
RTSP Path:	<input type="text"/> ex:rtsp://IP_Address/ Audio:G.711

1. Resolution

1920x1080@30fps, 1280x720@30fps, 640x480@30fps, 320x240@30fps, 176x144@30fps

2. Profile

Chose between Main or Baseline

3. Bitrate Control Mode

There are CBR (Constant Bit Rate) and VBR (Variable Bit Rate)

CBR: **32Kbps~8Mbps** (the higher the CBR is, the better the video quality is)

VBR: **Quantitative 1(Low) ~10(High)**: the higher the compression rate, the lower the picture quality is; vise versa. The balance between CVBR and network bandwidth will affect the picture quality. Select the VBR rate to avoid picture breaking up or lagging.

4. Video Frame Rate (**5~30 FPS**): The video refreshing rate per second.

5. GOP Size (**1, 1/2, 2**) **X FPS**: "Group of Pictures". The higher the GOP is, the better the quality is.

- 6. Video Format: **H.264** or **JPEG**
- 7. RTSP Path: RTSP output connecting path
- c. 3GPP Streaming mode:

3GPP Streaming Setting

Basic Mode Close (Format=H.264)

Resolution:

Video Bitrate:

Video Frame Rate:

RTSP Path:
ex:rtsp://IP_Address/v3 Audio:AMR

- 1. Resolution:

640x480@15fps, 320x240@15fps, 176x144@15fps

- 2. Video Bitrate:

32Kbps~1Mbps (the higher Video Bitrate is, the better the video quality is)

3. Video Frame Rate

The video refreshing rate per second.

4. RTSP Path: RTSP output name

3. Audio

The IP Camera supports 2-way audio. The user can send audio from the IP Camera built-in microphone to the remote PC; the user can also send audio from remote PC to IP Camera's external speaker.

- a. Audio from IP camera built-in microphone to local PC: select **Enable** to start this function and select the audio type.

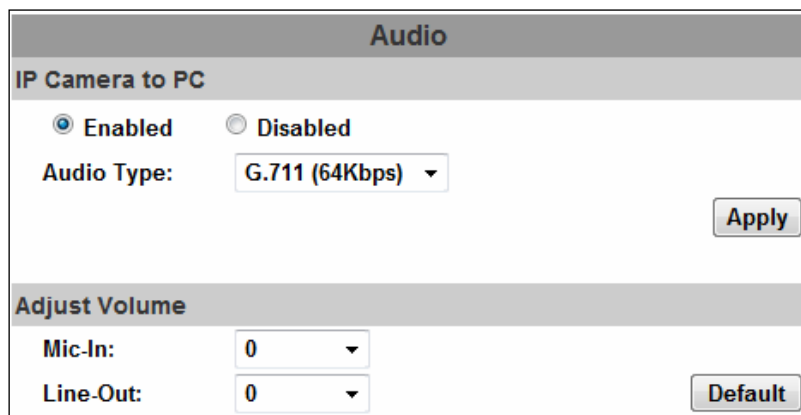

The screenshot shows a web-based configuration interface for the camera's audio settings. It is titled "Audio" and is divided into two main sections: "IP Camera to PC" and "Adjust Volume".

IP Camera to PC

- There are two radio buttons: "Enabled" (which is selected) and "Disabled".
- Below the radio buttons is a label "Audio Type:" followed by a dropdown menu currently showing "G.711 (64Kbps)".
- An "Apply" button is located to the right of the "Audio Type" dropdown.

Adjust Volume

- There are two dropdown menus: "Mic-In:" and "Line-Out:", both currently set to "0".
- A "Default" button is located to the right of the "Line-Out" dropdown.

b. Audio from local PC to IP Camera: Check **chatting** in the browsing page.



The Audio will not be smooth when the SD card is recording.

Note: When both **Chatting** and **Speaker Out** are selected, the built-in microphone may be automatically shut down to avoid echoing effects. If you wish to keep the two-way audio option active, select **Line out** in the **Audio** option, this way, the built-in microphone function will be enabled.

5.4. Event List

The IP Camera provides multiple event settings.

1. Event Setting

a. Motion Detection

Area Setting:	<input checked="" type="checkbox"/> Area 1	<input checked="" type="checkbox"/> Area 2	<input checked="" type="checkbox"/> Area 3
Sensitivity:	<input type="checkbox"/> 5	<input type="checkbox"/> 5	<input type="checkbox"/> 5
<input type="checkbox"/> Area 1:	<input type="checkbox"/> E-mail	<input type="checkbox"/> FTP	<input type="checkbox"/> Out1
<input type="checkbox"/> Area 2:	<input type="checkbox"/> E-mail	<input type="checkbox"/> FTP	<input type="checkbox"/> Out1
<input type="checkbox"/> Area 3:	<input type="checkbox"/> E-mail	<input type="checkbox"/> FTP	<input type="checkbox"/> Out1
Subject:	<input type="text" value="IP Camera Warning!"/>		
Interval:	<input type="text" value="10 sec"/> a period of time between every two motions detected.		
<input type="checkbox"/> Based on the schedule			

To enable motion detection, tick **Area 1/2/3**. Click **Area 1/2/3** in **Area Setting**, and draw an area on the preview screen. When motion is detected in the area, the word **Motion!** will be displayed on the live screen. The camera will send video or snapshot to specific mail addresses, trigger the output device, or save video to FTP/ Micro SD card/ Samba.

By selecting **save to SD card**, the video or snapshot will be saved to the Micro SD card. Also, by ticking **E-mail/ FTP/ Samba** on the **Log** option, the motion detection log will be sent to **E-mail/ FTP/ Samba** simultaneously.

- Interval: For example, when selecting "10 sec", once the motion is detected and the action is triggered, it cannot be triggered again within 10 seconds.
- Based on the schedule: When the option box is ticked, only during the selected schedule time the motion detection is enabled.

b. Tampering Detection

Tampering Detection	
Tampering:	<input type="radio"/> Enabled <input checked="" type="radio"/> Disabled
	<input type="checkbox"/> E-mail <input type="checkbox"/> FTP <input type="checkbox"/> Out1 <input type="checkbox"/> Save to SD card <input type="checkbox"/> Samba
Interval:	30 sec ▼

When the camera view is covered, moved, hit by strong light, or out of focus, the tampering detection will be triggered, and send snapshots to mail/FTP/Samba/SD card, or trigger the external alarm. For example:

Before Tampering Detection



Tampering Triggered (Defocused)



Before Tampering Detection



Tampering Triggered (Lens Covered)



Before Tampering Detection



Tampering Triggered (Glare)



Before Tampering Detection



Tampering Triggered (Camera Moved)



Interval: The tampering detecting interval. Take the diagram below as example. The interval is set for 30 second; the camera lens is covered during 10 - 40 sec. At time point B, the camera compares the view with time point A, and sends an alarm when it finds that the lens is covered. At time point C, the camera compares the view with time point B, and sends an alarm when it finds that the lens is uncovered.

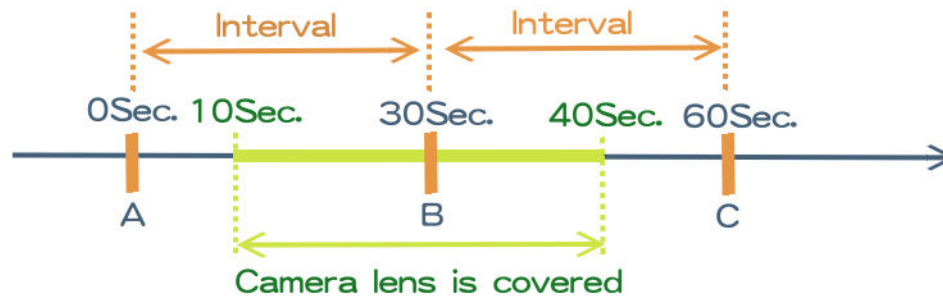

c. Record File

Record File	
File Format:	AVI File(with Record Time Setting) <input type="button" value="v"/>

When an event occurs, the IP camera will record a video clip or take snapshot, and then send to mail/ FTP/ Samba. Select the file format to be saved.

- AVI File (with Record Time Setting): Save AVI video file. The video length is according to the value set in Record Time Setting.

- JPEG Files (with Record Time Setting): This option is enabled when selecting **JPEG** video format in **streaming 1** on **Video Setting**, this option can be enabled. Select this option to save several JPEG picture files. The successive picture files cover a period of time according to the value set in **Record Time Setting**.
- JPEG File (Single File with Interval Setting): Save a single JPEG picture file when the event occurs.

d. Record Time Setting

Record Time Setting	
Pre Alarm:	5 sec
Post Alarm:	5 sec

When an event occurs, the IP camera can record a video clip or take a snapshot, and then send it via mail/ FTP/ Samba. Select the video recording length before and after the event is detected.

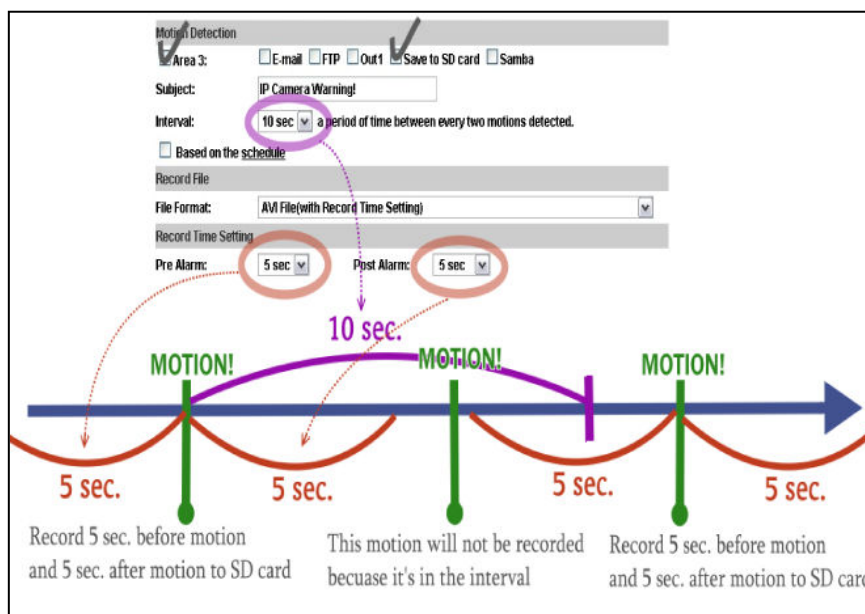

e. Network Dis-connected:

The IP Camera will scan the network. The image will be record to the SD card after the IP Camera detects network dis-connected, if set **Save to SD card**.

f. Network IP check:

After enabling IP Check, the IP camera can check if the network server is connecting. If the IP camera checking failed, the image will be recorded into the SD card.

Network IP Check

IP Check: Enabled Disabled

IP Address:

Interval: ▼

Check failed: Connection failed four times. Reboot IP Camera.
 Save to SD card

2. Schedule

Schedule

All	0	1	2	3	4	5	6	7	8	9	10	11	12	13	14	15	16	17	18	19	20	21	22	23
Mon.			■	■	■																			
Tue.			■	■	■																			
Wed.			■	■	■																			
Thu.			■	■	■																			
Fri.			■	■	■																			
Sat.																								
Sun.																								

■ With schedule setup.

Snapshot

Enabled Disabled

Snapshot: E-mail FTP Save to SD card Samba

Interval: Second(s) [1..50000]

File Name:

- a. Schedule: After completing the schedule setup, the camera data will be recorded according to the schedule setup.
- b. Snapshot: After enabling the snapshot function; the user can select the storage position of the snapshot file, the interval time of the snapshot and the reserved file name of the snapshot.
- c. Interval: The interval between two snapshots.

3. I/O Setting

I/O Setting	
Input Setting	
Input 1 Sensor:	N.O
Input 1 Action:	<input type="checkbox"/> E-mail <input type="checkbox"/> FTP <input type="checkbox"/> Out1 <input type="checkbox"/> Save to SD card <input type="checkbox"/> Samba
Subject:	GPIO In Detected!
Interval:	10 sec
	<input type="checkbox"/> Based on the <u>schedule</u>
Output Setting	
Mode Setting:	<input checked="" type="radio"/> OnOff Switch <input type="radio"/> Time Switch
Interval:	10 sec

a. Input Setting:

The IP Cam supports input and output. When the input condition is triggered the camera will trigger the relay; send video to mail addresses or /FTP server / SAMBA.

- Interval:

For example, when selecting **10 sec**, once the motion is detected and the action is triggered, it cannot be triggered again within 10 seconds.

- Based on the schedule:

Only when the option box is ticked, the selected schedule time for I/O is enabled. For example, if the 11th hour of Monday has not been colored in the schedule table, then no action will be triggered even if the camera detects input signal during 11:00~12:00 on Monday.

b. Output Setting:

The output mode affects the DO or relay out duration.

- ON/Off Switch: The camera triggers the external device and lasts for 10 seconds. You can turn off the alarm manually by clicking **off** at the right bottom of the live video page.

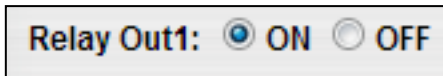

- Time Switch: The camera triggers the external device and lasts for certain time according to the internal setting, and the user is not allowed to break off the alarm manually.

4. Log List

Log List	
System Logs	Logs
Motion Detection Logs	Logs
I/O Logs	Logs
All Logs	Logs

Sort by System Logs, Motion Detection Logs and I/O Logs. In addition, System Logs and I/O Logs won't lose data due to power failure.

System Log
[2012/07/03 16:22:39] 192.168.40.159 login by admin.
[2012/07/03 11:54:22] 192.168.40.132 login by admin.
[2012/07/02 19:08:52] 192.168.40.132 login by admin.
[2012/07/02 18:24:50] 192.168.40.132 login by admin.
[2012/07/02 14:37:05] 192.168.40.132 login by admin.
[2012/07/02 14:18:26] 192.168.40.132 login by admin.
[2012/07/02 09:00:25] 192.168.40.132 login by admin.
[2012/06/29 19:51:34] Streaming 2 going to Close.
[2012/06/29 19:51:34] Streaming 1 Video bitrate going to 5000 Kbps.

5. Micro SD Card

a. Playback

Insert the Micro SD card before using it. Make sure to push the Micro SD card completely into the slot. Click the date listed on this page for showing the video list. The video format is AVI. Click the video to start Microsoft Media Player to play it. To delete the video, check it, and then click **Del**.

2006/04/17			Del
Time	Video	Event Type	<input type="checkbox"/>
09:06:22	090522f.avi	Network Dis-connected	<input type="checkbox"/>
09:05:52	090552f.avi	Network Dis-connected	<input type="checkbox"/>
09:06:22	090622f.avi	Network Dis-connected	<input type="checkbox"/>
09:06:52	090652f.avi	Network Dis-connected	<input type="checkbox"/>
09:07:22	090722f.avi	Network Dis-connected	<input type="checkbox"/>
09:07:52	090752f.avi	Network Dis-connected	<input type="checkbox"/>
09:08:22	090822f.avi	Network Dis-connected	<input type="checkbox"/>
09:08:51	090851f.avi	Network Dis-connected	<input type="checkbox"/>
09:09:21	090921f.avi	Network Dis-connected	<input type="checkbox"/>
09:09:51	090951f.avi	Network Dis-connected	<input type="checkbox"/>

b. SD Management

When choosing **The 1st day** the recording file will be kept for one day.

The oldest file will be deleted if the Micro SD card is full.

Playback

No SD card

SD Management

Auto Deletion: (Keep 1/ 2/ 3/ 4...days)

- Off
- The 1st day
- The 2nd day
- The 3rd day
- The 4th day
- The 5th day
- The 6th day**
- The 7th day
- The 8th day
- The 9th day
- The 10th day
- The 15th day
- The 20th day
- The 25th day
- The 30th day

Note : The use of the Micro SD card will slightly affect the operation of the IP Camera, such as affecting the frame rate of the video.

c. Copy to PC

You can insert the Micro SD card to the PC and read the files directly, or use **FlashGet** instead to download the files from the IP camera. (In this way you do not need to pull out the Micro SD card from the camera.)

For using **FlashGet** to download image and video data from the Micro SD card, please follow the steps:

(i) Enter data list and right-click **Files link daily**, select **save target as...** then save the link list to PC.

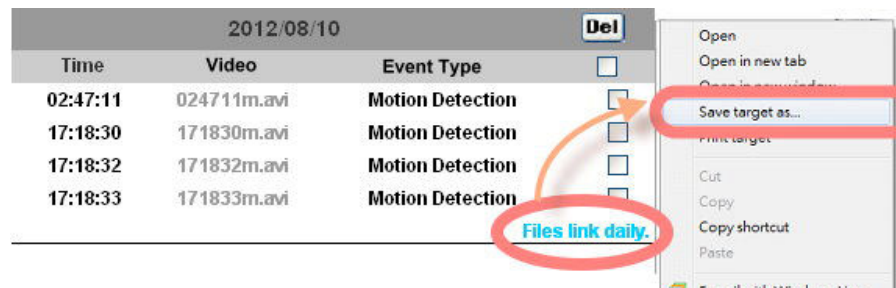

(ii) Open FlashGet, select **File** → **Import** → **Import list**, and find the link list file you just saved. The file name may be called **SD_list**.

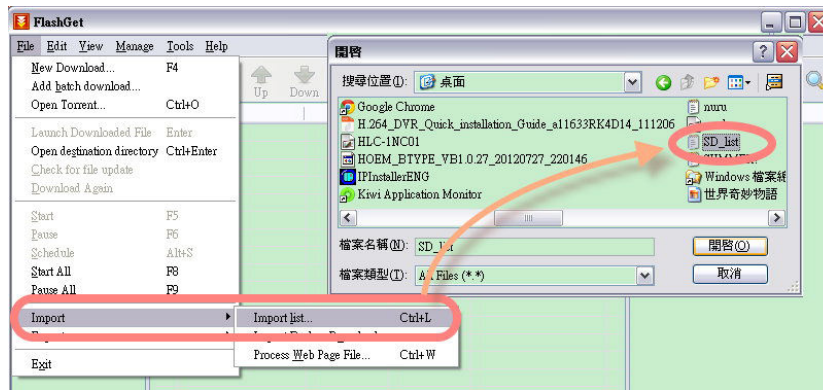

(iii) **FlashGet** will show you the link list, and you can tick the files you want to copy to your PC. Give the directory path in the new download window, and remember to enable **Login to Server**: key in the IP Camera username and password.

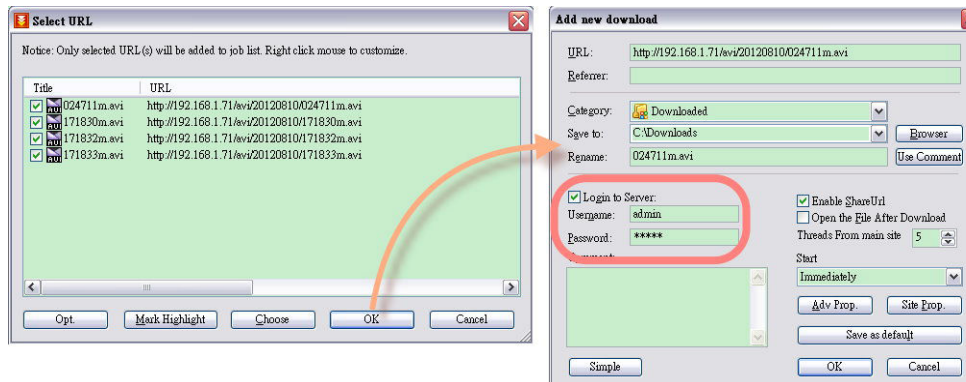

(iv) Click **OK** to start download.

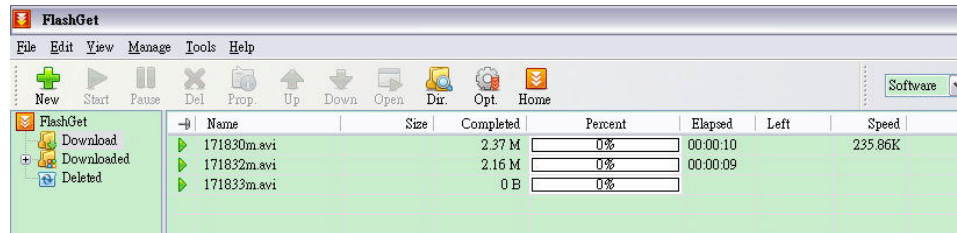

FlashGet is a free software that can be downloaded from FlashGet official website. The example above is based on **FlashGet ver.1.9.6**.

Chapter 6. Network Configuration

I. Configuration 1:

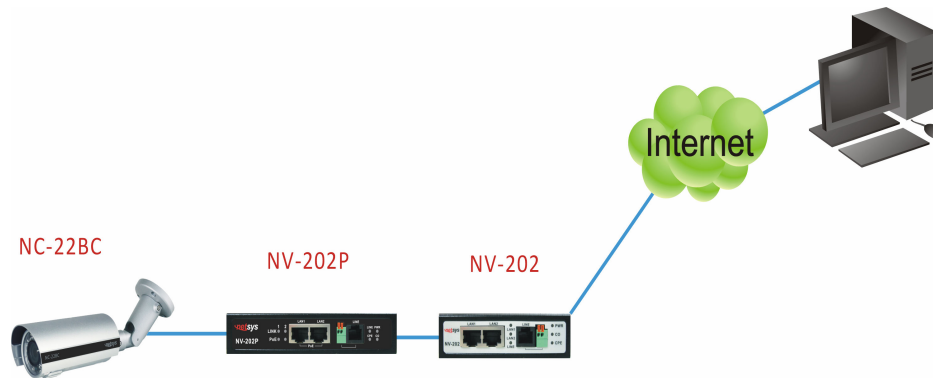

- a. Internet Access: NV-202 and NV-202P(Ethernet Extender)
- b. IP address: One real IP or one dynamic IP
- c. Only the IP Camera is connected to the internet.
- d. For fixed real IP, set up the IP into IP Camera. For dynamic IP, start PPPoE.

II. Configuration 2:

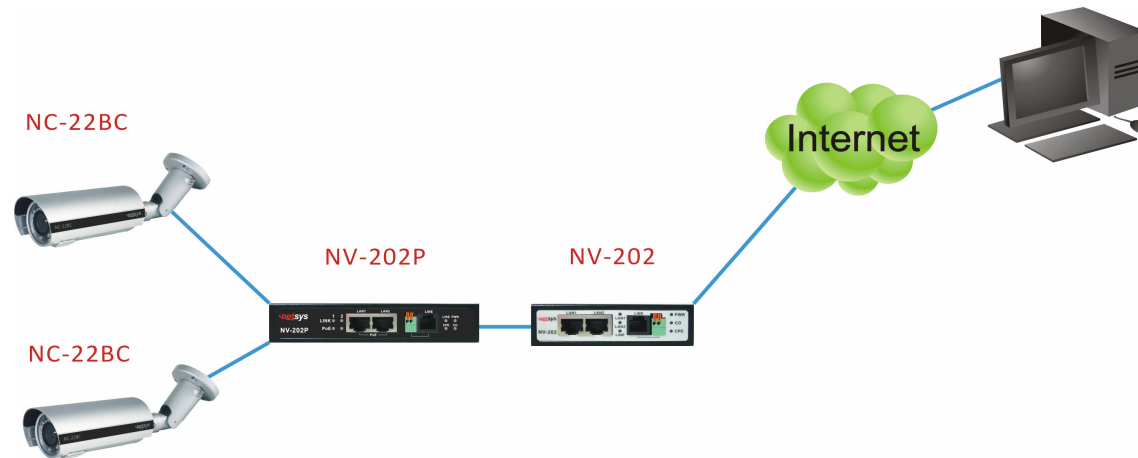

- Internet Access: NV-202 and NV-202P(Ethernet Extender)
- IP address: More than one real IP or one dynamic IP
- IP Camera and PC connect to the internet
- For fixed real IP, set up the IP into IP Camera and PC. For dynamic IP, start PPPoE.

Chapter 7. I/O Configuration

1. I/O Connection

a. Connect the **GND & DO** pin to the external relay (buzzer) device.

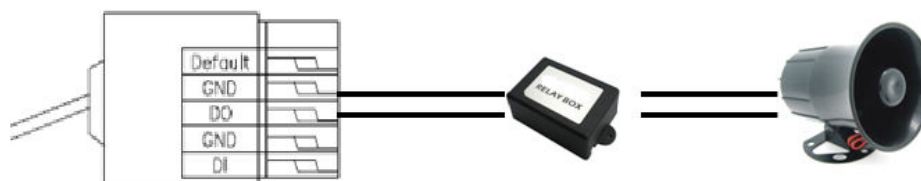

b. Connect the **GND & DI** pin to the external trigger device.

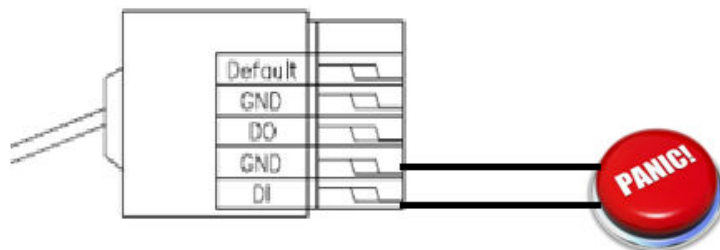

When no event occurs, **DO** output is **5V** (**DO** and **GND** are disconnected). As soon as the camera detects an event it will trigger and external alarm, **DO** output is **0V** (**DO** and **GND** are connected)

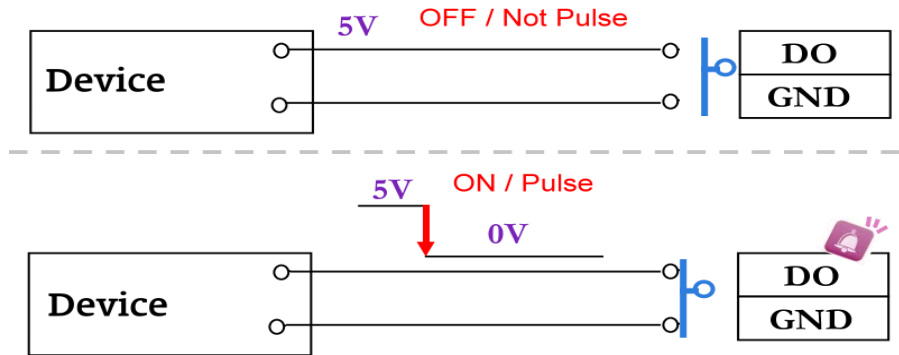

If you select **N.O** on **Input sensor setting**, when the switch contacts are opened, the camera input alarm will be triggered and will execute the action user has set, for example, send a snapshot to E-mail address.

If you select **N.C** in **Input sensor setting**, when the switch contacts are closed, the camera input alarm will be triggered and will execute the action user has set, for example, send a snapshot to E-mail address.

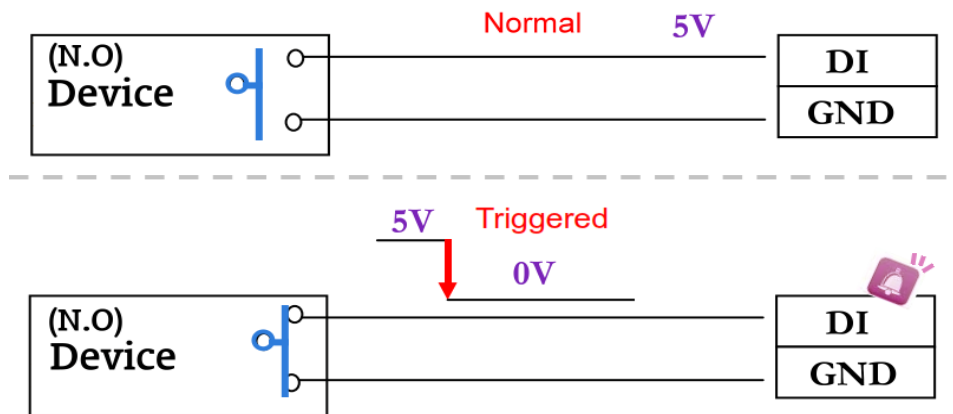

c. I/O PIN definition

- ◆ **GND (Ground):** Initial state is LOW
- ◆ **DO (Digital Output):** DC 5V
- ◆ **DI (Digital Input):** Max. 50mA, DC 5V

2. I/O Setup

a. Click I/O Setting from the system setup page via IE, and check **Out1** to enable I/O signal

I/O Setting

Input Setting

Input 1 Sensor:

Input 1 Action: E-mail FTP Out1 Save to SD card Samba

Input 2 Sensor:

Input 2 Action: E-mail FTP Out1 Save to SD card Samba

Subject:

Interval:

Based on the schedule

Output Setting

Mode Setting: OnOff Switch Time Switch

Interval:

b. Output Test

After the external input and output hardware is installed, you can use the **Relay Out** bottom on the live video page to test if DO / Relay Out works.

i. On Off Switch mode:

Clicking **ON** will trigger the external output device for 10 seconds. For example, your alarm buzzer will continuously ring for 10 seconds. After 10 seconds the buzzer stops ringing, or you can manually break off the output signal by clicking **OFF**

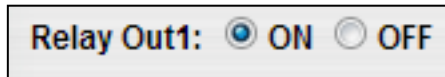

ii. Time Switch mode:

Click **Pulse**, the camera will trigger the external output device for several seconds; the duration length is according to the **interval** setting in Output Setting.

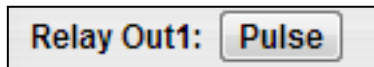

Chapter 8. Factory Default

If you forget your password, please follow the steps to set back the IP Camera to its factory default state.

- Remove the power and Ethernet cable.
- Take an electronic wire, plug one side of the wire into **Default** and the other side into **GND** on the terminal block as the picture below

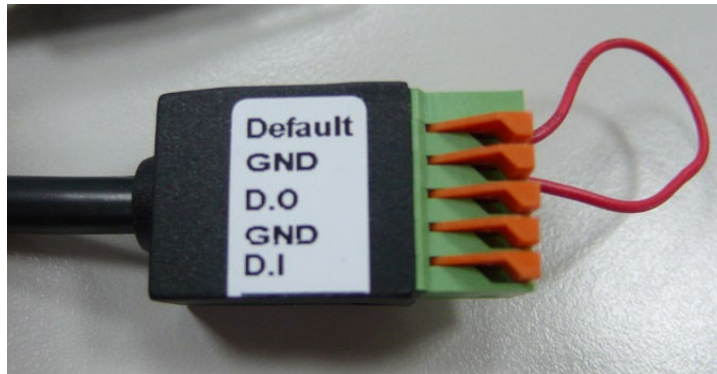

- Connect the power back to the camera. It will take around 30 seconds to boot the camera.
- Remove the wire and plug-in the Ethernet cable after the camera finishes booting.
- Re-login the camera using the default IP (<http://192.168.1.200>), and user name: **admin**, password: **admin**.

Chapter 9. Universal Password

If you forgot the password of your IP camera, you can reset the camera to factory default, or follow the procedure below to generate a universal password.

Note: Universal password will be valid only when you enable the function in **User Management**.

Step1 First, you need to know the IP address and MAC address of your IP camera. You can use **IP installer** to scan the LAN, and see the IP address and MAC address on the side column.

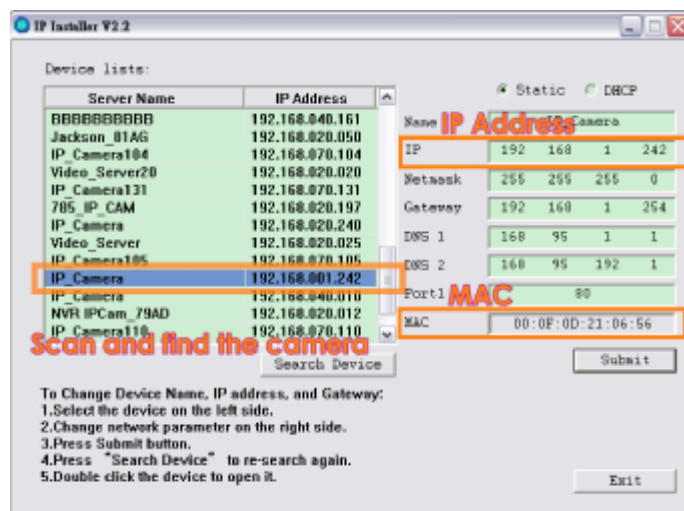

Or, if you already know the IP address of camera: Open the web browser, key in **http:// (IP address) /GetIPMAC.cgi** and press enter. The IP address and MAC address will be displayed on browser.

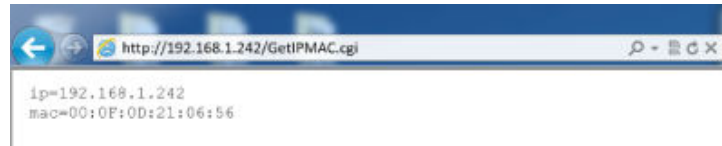

Step2 Find the .html file named **Universal Password** in CD-ROM. Click to open it.



Step3 Key in the camera IP address **IP Address** column and MAC address in **MAC** column, and then click **encoder**, a set of username and password will appear, as shown in the picture below:

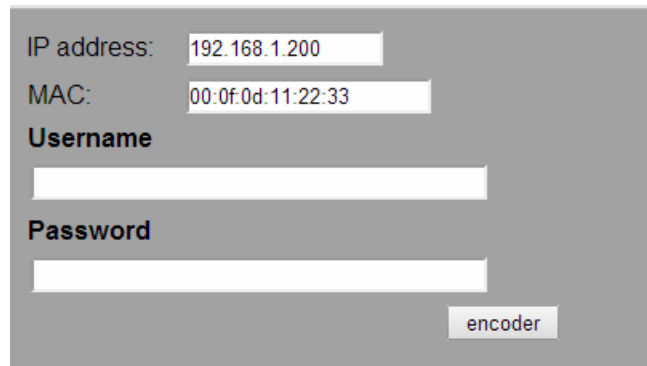

The universal username and password are generated from the IP address and MAC address you key-in, so if you change the camera IP address the universal password changes, too.

Step4 Take the generated username and password. Use them to log into the camera.

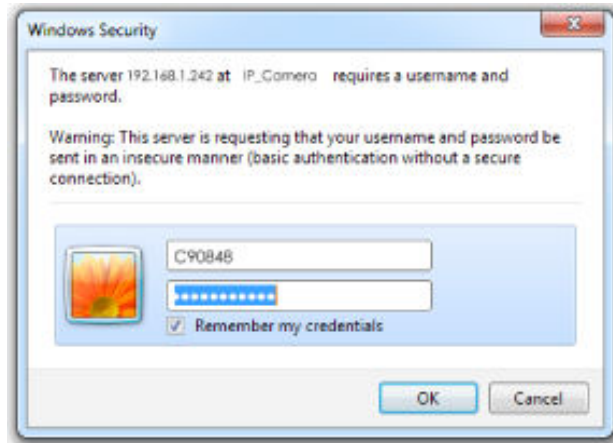

Step5 Now you can login as administrator. Turn to **User Management** page. The use of universal password does not affect the previous user setting, so the administrator account password does not change until you edit it. Please click **Edit** to give a new administrator password.

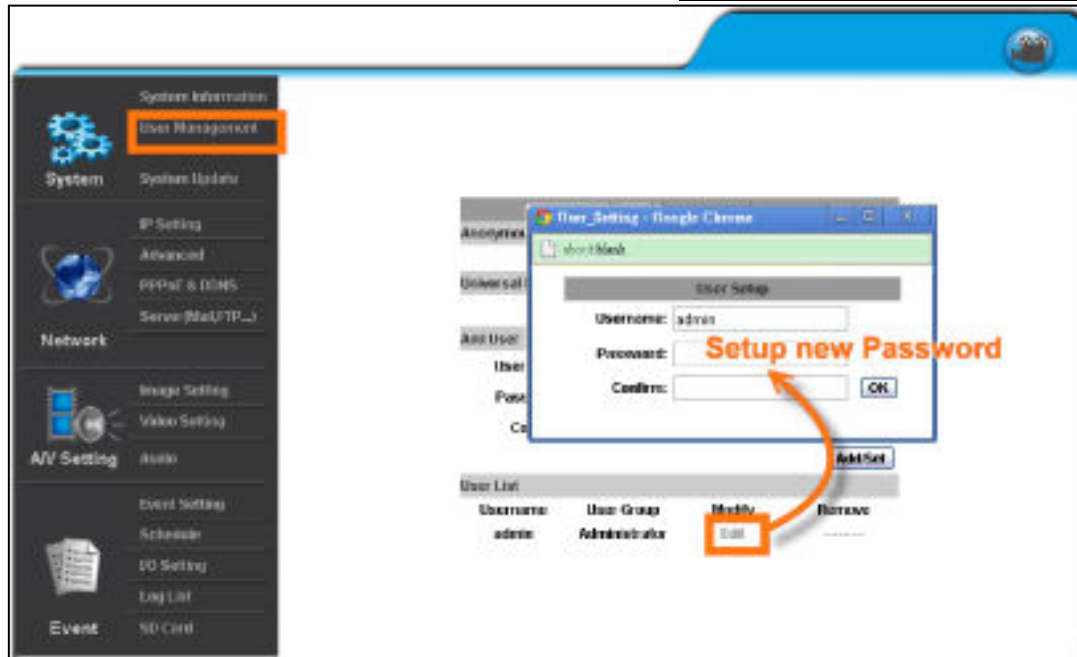

Appendix A. Micro SD Card Compatibility (Optional)

The following are the recommended Micro SD Cards:

Transcend	SDHC	class4	16GB
	SDHC	class4	32GB
	SD	class4	16GB
	SD	class4	32GB
	SDHC	class6	4GB
	SDHC	class6	8GB
	SDHC	class6	16GB
	SD	class6	4GB
	SD	class6	8GB
	SD	class6	16GB
SanDisk	SDHC	class4	4GB
	SDHC	class4	8GB
	SDHC	class4	16GB

Appendix B: Compliance Information

FCC Radio Frequency Interference Statement

This equipment has been tested and found to comply with the limits for a computing device, pursuant to Part 15 of FCC rules. These limits are designed to provide reasonable protection against harmful interference when the equipment is operated in a commercial environment. This equipment generates uses and can radiate radio frequency energy and, if not installed and used in accordance with the instructions, may cause harmful interference to radio communications. However, there is no guarantee that interference will not occur in a particular installation. If this equipment does cause harmful interference to radio or television reception, which can be determined by turning the equipment off and on, the user is encouraged to try to correct the interference by one or more of the following measures:

1. Reorient or relocate the receiving antenna.
2. Increase the separation between the equipment and receiver.
3. The equipment and the receiver should be connected to outlets on separate circuits.
4. Consult the dealer or an experienced radio/television technician for help.

Changes or modifications not expressly approved by the party responsible for compliance could void the user's authority to operate the equipment.

If this telephone equipment causes harm to the telephone network, the telephone company will notify you in advance that temporary discontinuance of service may be required. But if advance notice isn't practical, the telephone company will notify the customer as soon as possible. Also, you will be advised of your right to file a complaint with the FCC if you believe it is necessary.

The telephone company may make changes in its facilities, equipment, operations or procedures that could affect the



NC-22BC 2 Megapixels IR IP Camera User's Manual Ver.A2

proper functioning of your equipment. If they do, you will be notified in advance in order for you to make necessary modifications to maintain uninterrupted service.

This equipment may not be used on coin service provided by the telephone company. Connection to party lines is subject to state tariffs.

FCC Warning



These limits are designed to provide reasonable protection against harmful interference when the equipment is operated in a commercial environment. This equipment can generate, use, and radiate radio frequency energy and, if not installed and used in accordance with the instruction manual, may cause harmful interference to radio communications. Operation of this equipment in a residential area is likely to cause harmful interference in which case the user will be required to correct the interference at owner's expense.

CE Mark Warning



In a domestic environment, this product may cause radio interference in which case the user may be required to take adequate measures.

WEEE Warning



To avoid the potential effects on the environment and human health as a result of the presence of hazardous substances in electrical and electronic equipment, end users of electrical and electronic equipment should understand the meaning of the crossed-out wheeled bin symbol. Do not dispose of WEEE as unsorted municipal waste and have to collect such WEEE separately.

Warranty

The original product that the owner delivered in this package will be free from defects in material and workmanship for one year parts after purchase.

There will be a minimal charge to replace consumable components, such as fuses, power transformers, and mechanical cooling devices. The warranty will not apply to any products which have been subjected to any misuse, neglect or accidental damage, or which contain defects which are in any way attributable to improper installation or to alteration or repairs made or performed by any person not under control of the original owner.

The above warranty is in lieu of any other warranty, whether express, implied, or statutory, including but not limited to any warranty of merchantability, fitness for a particular purpose or any warranty arising out of any proposal, specification or sample. We shall not be liable for incidental or consequential damages. We neither assume nor authorize any person to assume for it any other liability.



WARNING:

DO NOT TEAR OFF OR REMOVE THE WARRANTY STICKER AS SHOWN, OR THE WARRANTY IS VOID.

Chinese SJ/T 11364-2014

部件名称	有毒有害物质或元素					
	铅(Pb)	汞(Hg)	镉(Cd)	六价铬[Cr(VI)]	多溴联苯(PBB)	多溴二苯醚(PBDE)
结构壳体	○	○	○	○	○	○
电路组	○	○	○	○	○	○
电源供应器	○	○	○	○	○	○
线材	○	○	○	○	○	○
包装及配件	○	○	○	○	○	○

○：表示该有毒物质在该部件所有均质材料中的含量均在 GB/T 26572 标准规定的限量要求以下。
 ×：表示该有毒物质至少在该部件的某依均质材料中的含量超出 GB/T 26572 标准规定的限量要求。

上述规范仅适用于中国法律